



Xserve

Setup Guide

Includes setup, expansion,
and hardware specifications
for the Xserve



© 2008 Apple Inc. All rights reserved.

Under the copyright laws, this manual may not be copied, in whole or in part, without the written consent of Apple. Your rights to the software are governed by the accompanying software license agreement.

The Apple logo is a trademark of Apple Inc., registered in the U.S. and other countries. Use of the “keyboard” Apple logo (Option-Shift-K) for commercial purposes without the prior written consent of Apple may constitute trademark infringement and unfair competition in violation of federal and state laws.

Every effort has been made to ensure that the information in this manual is accurate. Apple is not responsible for printing or clerical errors.

Apple
1 Infinite Loop
Cupertino, CA 95014-2084
408-996-1010
www.apple.com

Apple, the Apple logo, FireWire, Mac, Macintosh, Macintosh Products Guide, Mac OS, SuperDrive, and Xserve are trademarks of Apple Inc., registered in the U.S. and other countries.

The FireWire logo is a trademark of Apple Inc.

Apple Store is a service mark of Apple Inc., registered in the U.S. and other countries.

Intel, Intel Core, and Xeon are trademarks of Intel Corp. in the U.S. and other countries.

This product includes software developed by the University of California, Berkeley, and its contributors.

Other company and product names mentioned herein may be trademarks of their respective companies. Mention of third-party products is for informational purposes only and constitutes neither an endorsement nor a recommendation. Apple assumes no responsibility with regard to the performance or use of these products.

Simultaneously published in the United States and Canada.

034-4480/2008-01-01

Contents

5 About This Guide

7 Chapter 1: Installing the Xserve

8 Tools and Parts You'll Need

9 Choosing a Suitable Location

11 Installing the Xserve

20 Where to Go from Here

21 Chapter 2: Installing or Replacing Components

22 Xserve at a Glance—Internal Components

24 Installing or Replacing an Apple Drive Module

28 Removing or Installing a Power Supply

30 Opening and Closing the Xserve

33 Adding Memory

38 Installing a PCI Card

44 Replacing the Battery

47 Appendix A: Specifications

51 Appendix B: Safety and Maintenance

51 Important Safety Information

- 52 Handling the Xserve
- 53 Protecting the Optical Drive
- 54 Power Supply
- 54 Cleaning the Xserve
- 54 Apple and the Environment
- 55 Health-Related Information About Computer Use

- 57 Regulatory Compliance Information

About This Guide

This setup guide shows you how to install the Xserve in a rack and how to install or replace components inside the Xserve.

For information about unpacking the Xserve and installing it in a rack, see Chapter 1.

For information about installing or replacing drive modules, memory, PCI cards, power supplies, or the system battery, see Chapter 2.

For a summary of Xserve specifications, see Appendix A.

For safety and regulatory information, see Appendix B.

When You Finish Installing the Xserve

For information about starting up the Xserve for the first time, configuring the server software, and using the Xserve, see the *Xserve User's Guide* on the *Admin Tools and Xserve Diagnostics* CD.

To learn about the Mac OS X Server software installed on the Xserve, see *Mac OS X Server: Getting Started* (on the *Admin Tools and Xserve Diagnostics* CD) and *Mac OS X Server: Server Administration*.

Xserve Setup Guide, *Xserve User's Guide*, *Mac OS X Server: Getting Started*, *Mac OS X Server: Server Administration*, and other server guides are available at www.apple.com/server/documentation.

For More Information

The Apple Xserve Support website offers in-depth product information and technical resources, including articles, discussions, and downloadable software updates. Visit the site at www.apple.com/support/xserve.

Installing the Xserve

1

This chapter shows you how to install the Xserve in an equipment rack.

The information in this chapter will help you gather the tools you'll need, choose a suitable location for the Xserve, and install it in a rack. When you finish installing the Xserve, you'll be referred to the *Xserve User's Guide* for information about starting up the Xserve for the first time.

Tools and Parts You'll Need

- A medium-size (#1) Phillips screwdriver
- The slide rails, rail extensions, and alignment tool that come with the Xserve

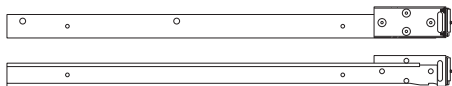

Rails for use with racks of all depths (2)

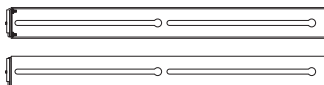

Short extensions for racks 24 to 29 inches deep (2)



Long extensions for racks 29 to 36 inches deep (2)



Alignment guide



Enclosure key

Choosing a Suitable Location

The Xserve is designed for rack mounting. Review the following paragraphs to be sure the location you choose satisfies the Xserve space, electrical, and environmental requirements.

Rack Compatibility

You can install the Xserve in any open or closed (cabinet-style) 19-inch-wide four-post rack from 24 to 36 inches deep using threaded-hole or square-hole rails, depending on which came with the Xserve. The Xserve occupies 1.75 inches (1U) of vertical rack space.

Important: Your rack should satisfy the American National Standards Institute (ANSI)/ Electronic Industries Association (EIA) standard ANSI/EIA-310-D-92, International Electrotechnical Commission (IEC) 297, and Deutsche Industrie Norm (DIN) 41494.

Rack Stability

Make sure the rack is stable and strong enough to support installed equipment. When working with equipment in the rack, never slide out more than one unit at a time, and keep all other equipment secured in the rack.

WARNING: Do not put a display or any other device on top of the Xserve. Extra weight can strain your rack's rails, which can make your rack unstable. If your rack is unstable, the Xserve and whatever is on top of it can fall on you. Also, any weight on top of the case could damage essential components inside the Xserve.

Space Requirements

Air to cool the Xserve flows from front to back. Make sure nothing blocks any of the openings in the front and back panels and case of the Xserve. When installed, the Xserve slides in and out of the rack from the front. Make sure you have at least 36 inches clear in front of the Xserve so you can remove it.

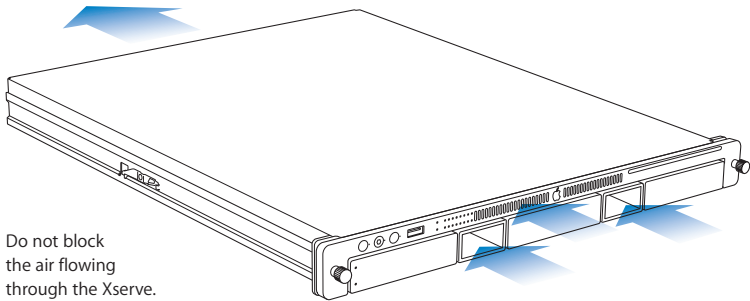

Do not block the air flowing through the Xserve.

Electrical Power Requirements

Be sure that the available circuitry and power connections are adequate for the combined power needs of the Xserve and all other equipment in the rack. See Appendix A for information about the electrical power requirements of the Xserve. Make sure that the power connections for the Xserve and all other equipment are grounded according to local and national standards.

Operating Environment

Make sure that the ambient temperature in the rack is within the limits established for the Xserve and all other equipment. See Appendix A for the Xserve operating temperature requirements. Make sure that both the rack itself and the room where the rack is located are sufficiently ventilated to maintain the necessary temperature range.

Installing the Xserve

Follow these instructions to install the Xserve in an equipment rack.

Installation Summary

- 1 Remove the shipping material.
- 2 Assemble a pair of slide rails that are the right length for your rack.
- 3 Install the rails loosely in the rack.
- 4 Align and secure the rails.
- 5 Slide the Xserve into the rack.

Installing Optional Components Before You Begin

To work inside the Xserve, you need to remove it from the rack. If you plan to install additional memory, PCI cards, or other internal components before you start using the Xserve, you can do so either before or after you install the Xserve in the rack. For help installing components, see Chapter 2.

Step 1: Remove the Protective Shipping Materials

- 1 Remove the Xserve from its box and place it on a flat surface.
- 2 Remove the protective faceplate by unscrewing the thumbscrews on each side of the faceplate and lifting it off.

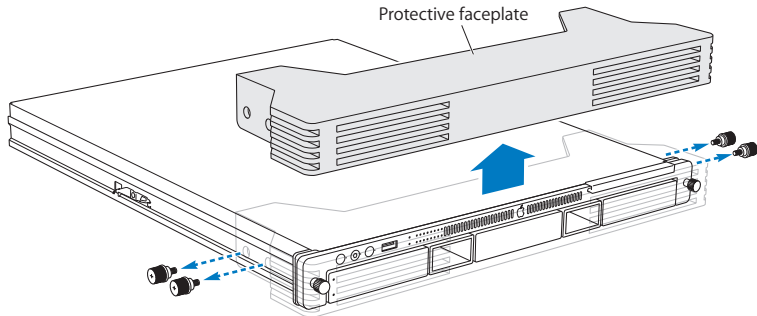

- 3 Remove any plastic film covering the front or top of the Xserve.

Note: Do not remove the small plastic protector in the optical drive slot. Leave this protector in place until the Xserve is secured in the rack. Keep the protector and return it to the optical drive slot whenever you move the Xserve or pack it for shipping.

Step 2: Assemble the Mounting Rails

The Xserve comes with both short and long extensions that you combine with standard front rails to create a pair of rails that are the right depth for your rack.

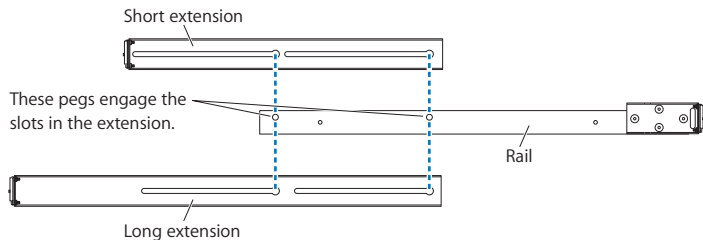

- 1 Slide a matching rear extension onto each of the two front rails.

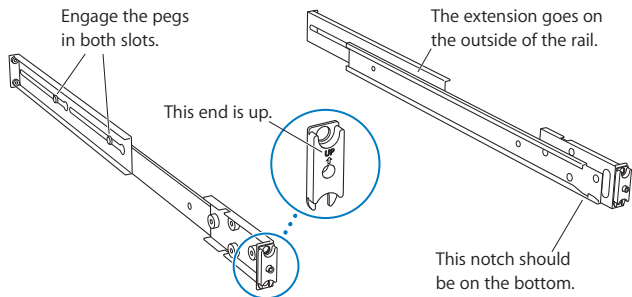

Step 3: Mount Rails Loosely in the Rack

- 1 Place an assembled rail in the rack (it will support itself temporarily while you gather the fasteners). The way you fit the rail depends on the rack.
 - If you have a threaded-hole rack, start with the rail flanges outside the rack posts and compress the rail into position.

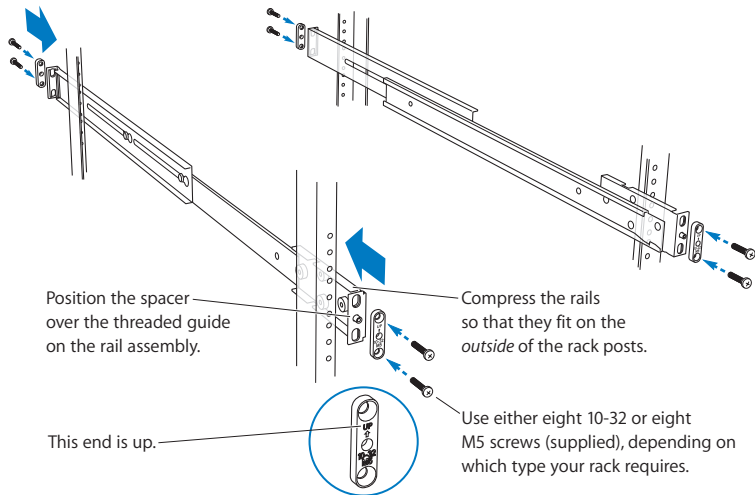

- If you have a square-hole rack, start with the rail flanges inside the posts and expand the rail between the front and rear posts until the small round guide on each flange extends through the rail.

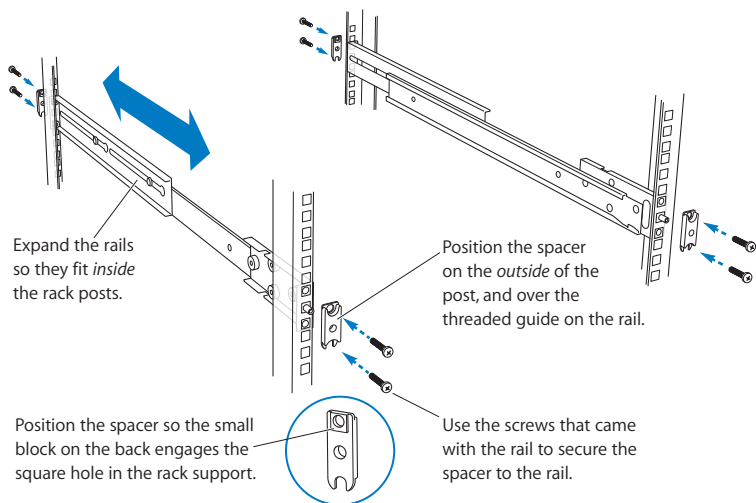

- 2 Slide a spacer, arrow up, over the small round guide at the ends of each rail and install the mounting screws finger tight.

Note: Don't tighten the mounting screws until you align the rails in the next step.

Step 4: Align and Secure the Rails

To make sure the Xserve slides easily in and out of the rack, use the alignment guide to position the rails in the rack before tightening the mounting screws.

- 1 Insert the alignment guide in the front of the rails.

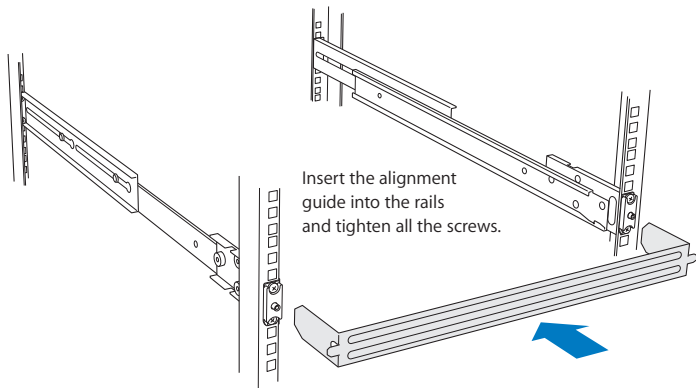

- 2 Tighten the front mounting screws

Important: If you have a square-hole rack, make sure the raised alignment block on the back of each mounting spacer is seated properly in the hole in the rack post as you tighten the screws.

- 3 Tighten the rear mounting screws.
- 4 Remove the alignment guide.

Step 5: Slide the Xserve into the Rails

- 1 Guide the slides on the Xserve into the channels on the rails.

Important: Make sure both the left and right slides on the Xserve go inside the rail channels. If you have difficulty, set aside the Xserve and use the alignment guide to check the spacing between the rails.

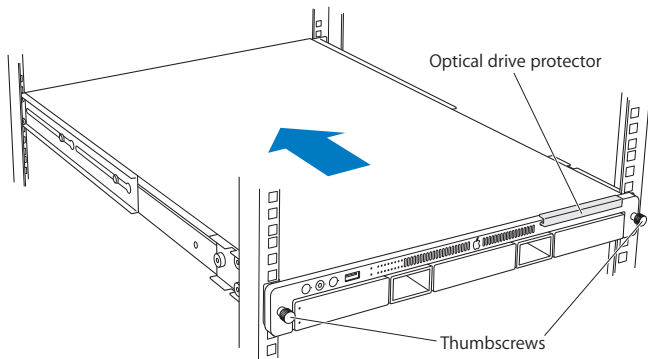

- 2 Slide the Xserve into the rack until it stops.
- 3 Tighten the thumbscrews at each end of the front panel to secure the Xserve in the rack.
- 4 Remove the plastic protector from the optical drive slot.

Note: Keep the protector and return it to the optical drive slot whenever you move the Xserve to another location or pack it for shipping.

Step 6: Connect the Cables

- 1 Connect a power cord to the power supply and secure it with the wire clip.

Note: The fan in the power supply and some system status lights come on when you connect the power cord, before you turn on the Xserve.

- 2 Connect the network cables.

Note: If you're using only one Ethernet cable, connect it to port 1.

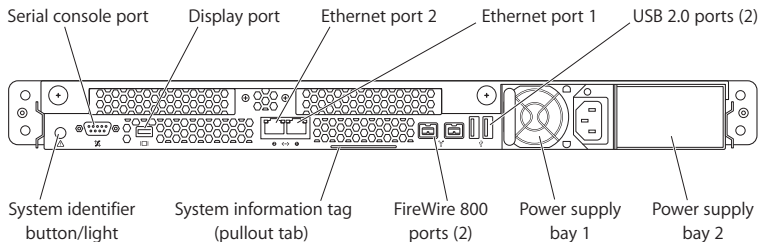

Step 7: Connect a Keyboard, Display, and Mouse (Optional)

You can connect a display, keyboard, and mouse directly to the Xserve. You can also manage the Xserve without connecting a display or keyboard by using tools such as Server Admin, Server Monitor, Apple Remote Desktop, and the command line.

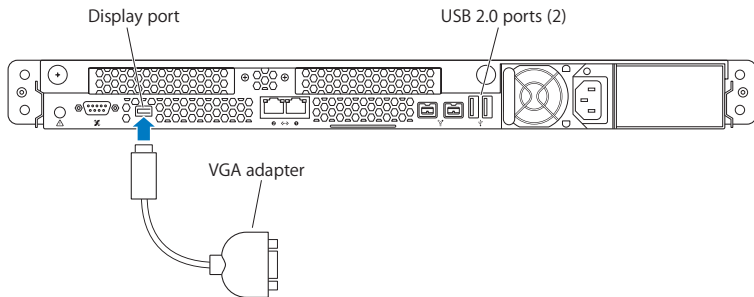

- 1 Connect the keyboard to one of the USB ports on the back panel.
- 2 Connect the mouse to the second USB port or to the keyboard.
- 3 Connect the video cable.

To use the built-in video card, connect the video cable to the display port on the back panel using the appropriate adapter.

To use an optional PCI video card, connect the display's video cable to the card.

Note: The Xserve comes with a mini-DVI to VGA adapter. A mini-DVI to DVI adapter is sold separately. A mini-DVI to video adapter is not supported. You may need a different adapter to connect a display to an optional PCI video card.

Where to Go from Here

When you finish installing the Xserve, you can find information about starting up, configuring, and using it in these guides:

- *Xserve User's Guide*, a PDF file on the *Admin Tools and Xserve Diagnostics CD*
- *Mac OS X Server: Getting Started*, a PDF file on the *Admin Tools and Xserve Diagnostics CD*
- *Mac OS X Server: Server Administration*, a PDF file located at: www.apple.com/server/documentation

Starting Up the Xserve

The *Xserve User's Guide* includes:

- An overview of Xserve controls and components
- Information about how to start up and shut down the Xserve
- Tips on monitoring the status of the Xserve and the services it hosts
- Instructions for updating or reinstalling the server software
- Solutions to some common problems

Configuring the Server Software

The first time you turn on the Xserve, the Server Assistant asks you for basic information that Mac OS X Server needs to start up and connect to the network. For information about setting up a standard or workgroup server, see *Mac OS X Server: Getting Started*. For information about setting up an advanced server, including remote installation and setup, and automated setup, see *Mac OS X Server: Server Administration*. For information about additional settings for your Intel-based Xserve, see the *Xserve User's Guide*.

Installing or Replacing Components

2

This chapter shows how to install or replace drive modules and internal Xserve components.

You can add or replace these components while the Xserve is in the rack:

- Drive module (page 24)
- Power supply (page 28)

To install these components, you must remove the Xserve from the rack and open it:

- Memory (page 33)
- PCI card (page 38)
- Battery (page 44)

For a quick glance inside the Xserve, turn the page.

Xserve at a Glance—Internal Components

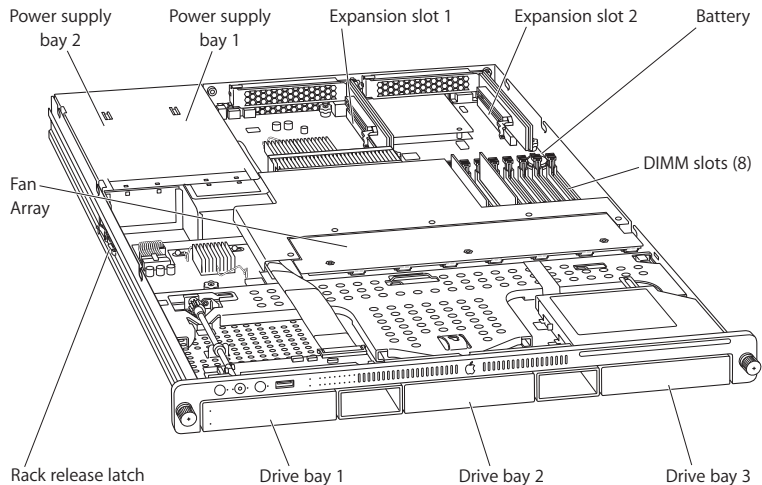

Power supply bays

You can install one or two power supplies in the Xserve. When two supplies are installed, they share the load. If one supply fails, the other takes over the full load. For information, see “Removing or Installing a Power Supply” on page 28.

Battery

The battery on the main logic board powers the system clock and preserves basic system settings (in NVRAM) when power supplies are disconnected. For information, see “Replacing the Battery” on page 44.

PCI-X and PCI Express card slot (slot 1)

You can install a half-length (6.6 inch) PCI-X or PCI Express card in this slot using the appropriate riser. For information, see “Installing a PCI Card” on page 38.

PCI Express slot (slot 2)

You can install a full-length (9 inch) PCI Express card in this slot using a PCI Express riser. For information, see “Installing a PCI Card” on page 38.

DIMM slots

You can expand memory in the Xserve up to 32 gigabytes (GB) by installing pairs of fully buffered, error-correcting dual inline memory modules (800 MHz DDR2 ECC FB-DIMMs) in these slots. For information, see “Adding Memory” on page 33.

Fan array

The fan array draws cooling air through the Xserve from front to back.

Rack release latch

This latch stops the Xserve about halfway out of the rack. Press to release.

Drive bays

You can install SAS (Serial Attached SCSI) and SATA (Serial ATA) drives. For information, see “Installing or Replacing an Apple Drive Module” on page 24.

Installing or Replacing an Apple Drive Module

If you're not using an Xserve RAID card, the drive modules in the Xserve are hot-pluggable, so you can add, remove, or replace them while the Xserve is operating. A status light on the drive handle indicates when it's safe to remove a drive without risk to the information stored on it.

If you are using an Xserve RAID card, you can add, remove, or replace failed hard drives while the Xserve is operating. However, to replace an entire RAID set, turn off the Xserve before adding, removing, or replacing drives.

About Drive Modules for the Xserve

The Xserve accepts both SAS (Serial Attached SCSI) and SATA (Serial ATA) drive modules. If you are using an Xserve RAID card, use drive modules that are the same size and type.

To install or replace a drive module:

- 1 If the Xserve case is locked, use the enclosure key to unlock the security lock on the front panel.

2 Remove the blank drive module or the drive module that's currently installed.

If there is a blank drive module in the bay, press the handle on the front to pop it out. Then pull the module out and put it in a safe place.

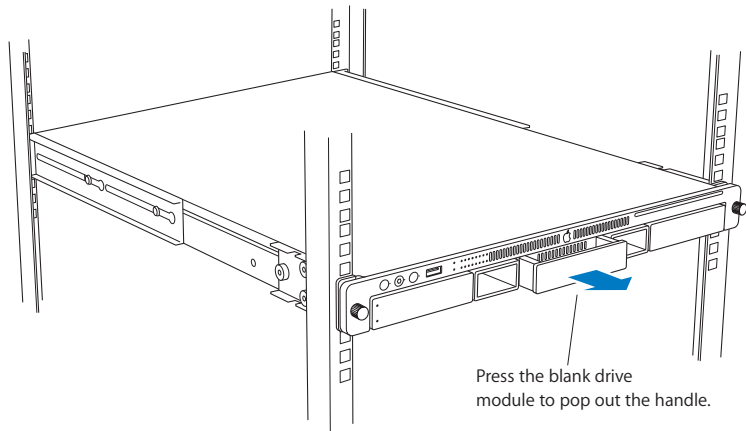

Important: Save the blank drive module. Always keep a blank drive module in any unused drive bay to maintain proper airflow through the Xserve.

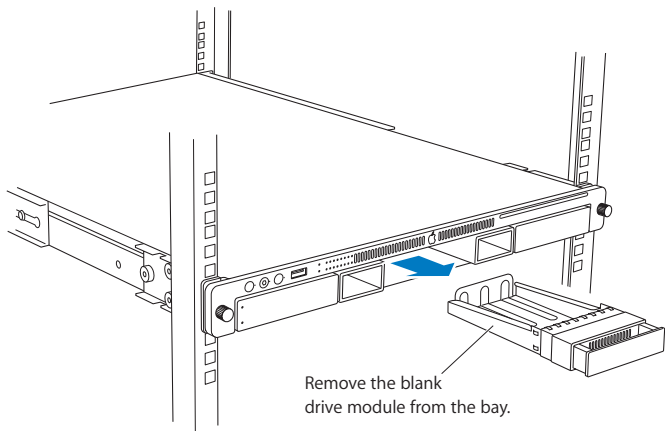

If there is a drive module already in the bay:

- a** Make sure the drive currently in the bay is not being used by any application or being shared by the Xserve. (See the Mac OS X Server documentation for information about shared volumes.)
- b** Unmount all volumes hosted by the drive using the Mac OS X Server command-line tools or by dragging the volume icons to the Trash.
- c** Press the handle on the drive module so the handle pops out.
- d** Wait for the green, upper disk status light to go off. Then grasp the handle, pull the drive module out of the bay, and set it aside.

- 3 Pick up the drive module you are installing, press and release its handle to open it, and slide the module into the bay until it is firmly seated.

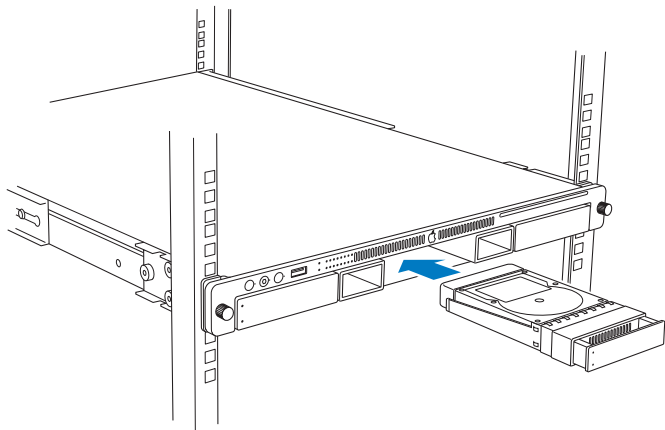

- 4 Press the handle in flush with the front panel.
The disk status light turns green to indicate normal operation.

Removing or Installing a Power Supply

You can replace or install a power supply from the back panel without removing the Xserve from the rack. If the Xserve has two power supplies, they are hot-swappable; the Xserve continues to operate using only one supply while the second is removed.

WARNING: Install power supplies with a rating of at least 750 Watts. The power supplies that come with previous Xserves are rated at less than 750 Watts.

To remove a power supply:

- 1 Unclip and unplug the power cord from the power supply you are removing.
- 2 Pull the handle to release the power supply and slide it out of the bay.



WARNING: The power supplies in a running Xserve might be hot.

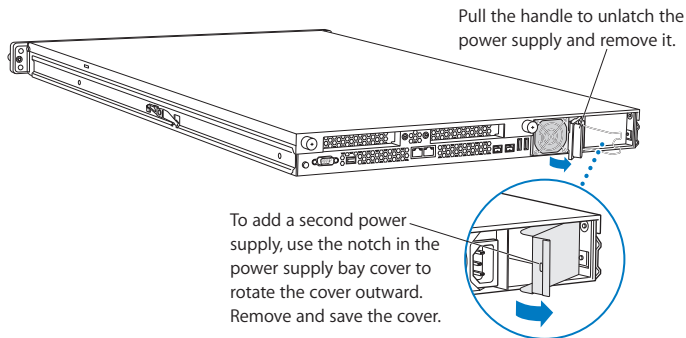

To install a power supply:

- 1 Pull to open the handle on the new power supply, slide it all the way into the bay, and then press the handle to seat the power supply and lock it in place.

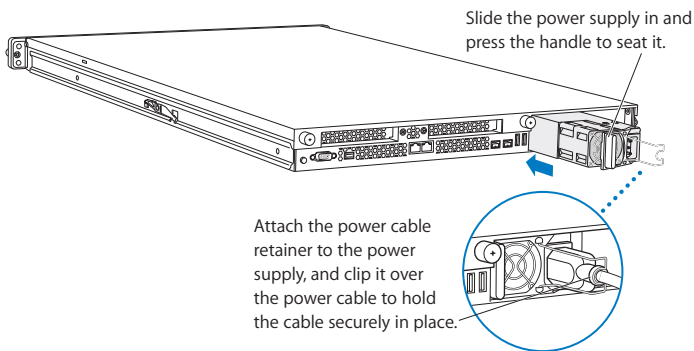

- 2 Connect the power cord to the power supply and clip the power cable retainer over the power cord.

If the Xserve is already running on a second power supply, the status light on the new supply turns green to indicate normal operation as it starts sharing the load. If the Xserve is not turned on, the supply status light blinks green when the power cord is plugged in to an outlet with power.

Opening and Closing the Xserve

Before you can install or replace memory, PCI cards, or the system battery, you need to shut down the Xserve, remove it from the rack, and open it.

Working Safely Inside the Xserve

Always touch the Xserve chassis to discharge static electricity before you handle any components inside the Xserve. To avoid generating static electricity, do not walk around the room until you have finished installing the PCI card, memory, or other internal component and have replaced the Xserve cover. To minimize the possibility of damage due to static discharge, wear an antistatic wrist strap while you work inside the Xserve.

To open the Xserve:

- 1 Shut down the Xserve (see the *Xserve User's Guide* for help) and then wait a few moments to let the Xserve internal components cool.



WARNING: Always shut down the Xserve before opening it to avoid damaging its internal components or the components you want to install. Don't open the Xserve or try to install items inside while it is turned on. Even after you shut down the Xserve, its internal components can be very hot. Let it cool down before you open it.

- 2 If the Xserve case is locked, use the enclosure key to unlock the security lock on the front panel.
- 3 Unplug all cables from the Xserve.

Note: If you have trouble releasing a cable from the back panel, try using a small screwdriver or other flat tool to depress the tab on the cable connector.

- 4 Loosen the thumbscrews at both ends of the front panel.
- 5 Grasp the thumbscrews and pull the Xserve forward until the safety latches engage (about halfway out of the rack).

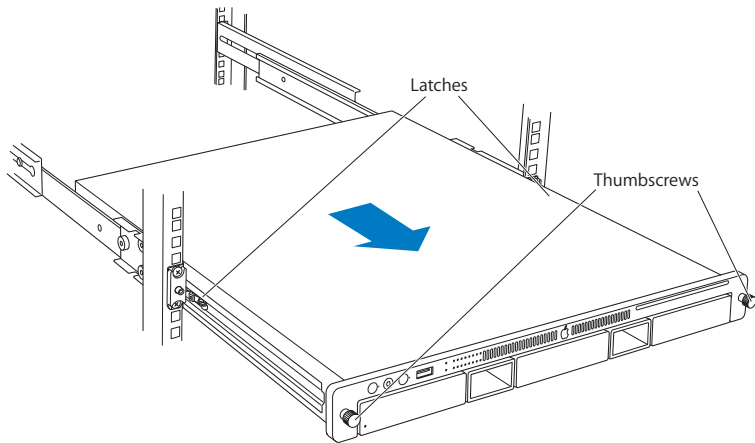

- 6 When the safety latches engage, grip the Xserve where it emerges from the rack, press down on the latch tabs with your thumbs, and carefully slide the Xserve the rest of the way out of the rack rails. Make sure to account for having to carry the full weight of the Xserve without the rack offsetting some of the burden. Set the Xserve on a flat surface.

- 7 Loosen the thumbscrews at the back of the top cover and slide the cover back and up to remove it.

If you have difficulty removing the cover, check the enclosure lock on the front panel.

Important: To minimize the possibility of damage to Xserve components due to static discharge, wear an antistatic wrist strap while you work inside the Xserve.

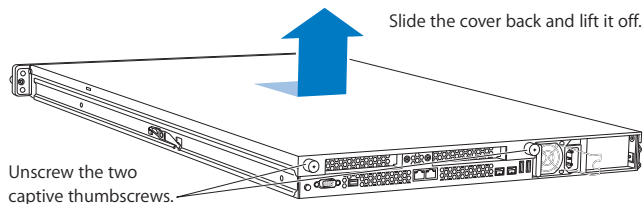

- 8 When you're finished working inside the Xserve, replace and secure the cover, slide the Xserve back into the rack, and tighten the front thumbscrews to secure the Xserve in the rack. If the server case was locked, use the enclosure key to lock the security lock on the front panel.

Adding Memory

The Xserve has 8 memory slots. The systems come with at least 1 gigabyte (GB) of memory on two fully buffered dual inline memory modules using Error-Correcting Code (800 MHz DDR2 ECC FB-DIMMs). To improve performance and capacity, you can install additional DIMMs for a total of up to 32 GB of memory.

The 8 memory slots are labelled DIMM 1 through DIMM 8.

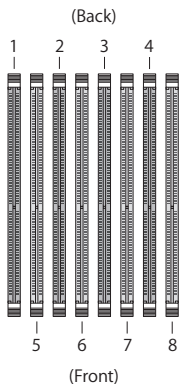

About Memory for the Xserve

You can use the following memory in the Xserve:

- 800 MHz DDR2 ECC FB-DIMMs
- 1 GB, 2 GB, or 4 GB in matching pairs (optimally, 4 or 8 identical DIMMs)
- Error-correcting code (ECC)

Important: Apple recommends that you use Apple-approved FB-DIMMS. Other FB-DIMMs might degrade the performance of the Xserve. DIMMs from older Xserve systems are not compatible with this Xserve.

Note: Before you purchase DIMMs other than those recommended by Apple, make sure that the memory manufacturer conforms to the Joint Electron Device Engineering Council (JEDEC) specification. Make sure that the DIMMs support the correct timing modes and that the Serial Presence Detect (SPD) feature has been implemented in accordance with the JEDEC specification. To check DIMM compatibility, see the Macintosh Products Guide on Apple's website at www.apple.com/guide. You can purchase Apple-approved memory online from the Apple Store at www.apple.com/store.

Installation Rules

You must install DIMMs in pairs, and the DIMMs in each pair must be identical. The first pair is installed in slots 1 and 2. Install the next pair in slots 3 and 4. Subsequent pairs go in slots 5 and 6, and then slots 7 and 8.

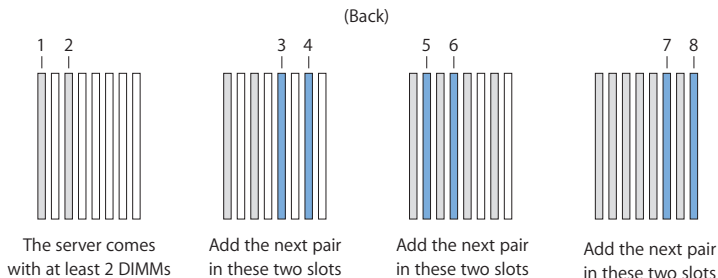

(Front)

For Best Performance

For the best possible performance, install eight identical DIMMs in slots 1–8. If you don't have eight matching DIMMs, install four identical DIMMs in slots 1–4 and a second set of four identical DIMMs in slots 5–8.

Always fill slots 1–4 before you install DIMMs in slots 5–8. After you fill slots 1–4, add a full set of four DIMMs in slots 5–8 instead of just a pair in slots 5 and 6.

To install memory:

- 1 Review the memory installation rules and make sure you have the right type of DIMMs.
- 2 Shut down the Xserve and unplug all cables.

Important: Be sure the Xserve is turned off and the power cords are unplugged before you install or remove memory.

- 3 Remove the Xserve from the rack and open it. For instructions, see “Opening and Closing the Xserve” on page 30.



WARNING: Always wait 5 to 10 minutes for the Xserve to cool down before you try to install memory. DIMMs that are already installed and other components near the DIMM slots may be very hot.

- 4 Open the ejectors on a slot by pushing them outward.
Important: Don't touch the gold connectors on the DIMMs.
- 5 Without touching its gold connectors, align a DIMM in the slot and push straight down on both ends until the DIMM is seated and the ejectors snap upright.
- 6 Repeat for the second DIMM of the pair and for additional pairs.
Important: Be sure to add DIMMs in the order shown in the illustration.

Ejectors Notch Connectors

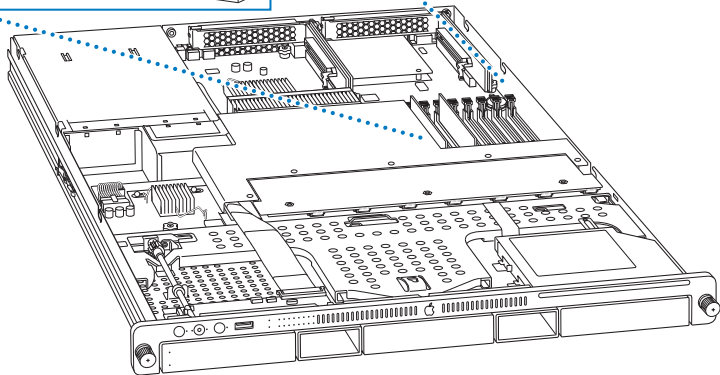
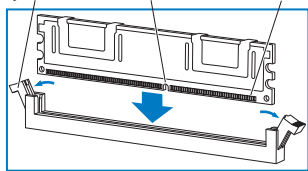

Installing a PCI Card

The Xserve has two PCI slots:

- Slot 1, which accepts half-length (6.6 inch) PCI Express or PCI-X cards
- Slot 2, which accepts full-length (9 inch) PCI Express cards

To install a card, you first insert it into a matching riser, and then install the riser into the slot. The type of card you can install depends on the riser you use:

- A PCI Express x16 riser can only go in slot 2, and accepts only PCI Express cards
- A PCI Express x8 riser can only go in slot 1, and accepts only PCI Express cards
- A PCI-X riser can only go in slot 1, and accepts only PCI-X cards

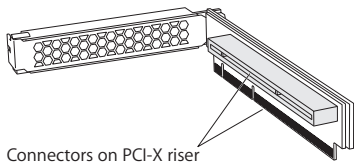
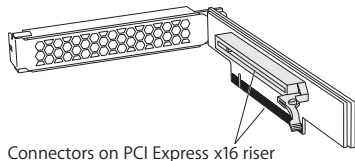
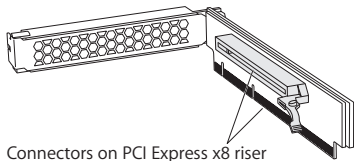

About PCI Cards for the Xserve

The Xserve accepts PCI cards that meet these specifications:

Slot 1

- 64-bit PCI-X 133 MHz cards (using a PCI-X riser)
- 32-bit or 64-bit 33, 66, or 100 MHz PCI or PCI-X cards with 3.3 volt universal signaling
- x8 PCI Express cards using a PCI Express riser
- 6.6 inch maximum length
- 25 Watt maximum power consumption

Slot 2

- x16 PCI Express 2.0 cards
- 9 inch maximum length
- 25 Watt maximum power consumption

To install a PCI card:

- 1 Shut down the Xserve and unplug all cables.

Important: Be sure the Xserve is turned off and the power cords are unplugged before you install or remove a PCI card or riser.

- 2 Remove the Xserve from the rack and open it. For instructions, see “Opening and Closing the Xserve” on page 30.

 **WARNING:** Always wait 5 to 10 minutes for the Xserve to cool down before you work around the PCI slots. Components near the slots may be very hot.

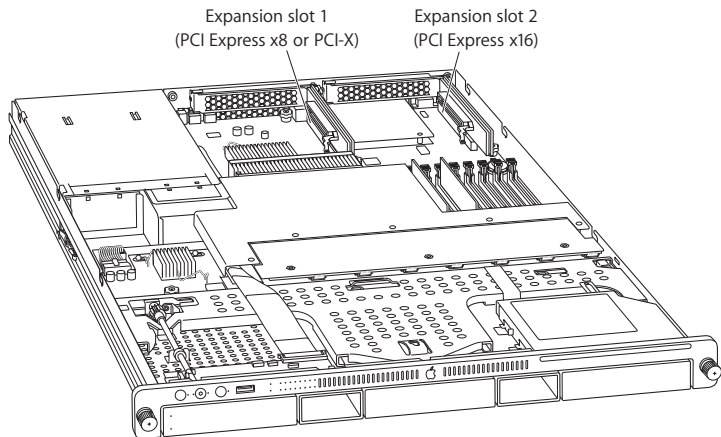

- 3 Loosen the two captive screws that secure the riser bracket to the back panel and gently pull the bracket and riser straight up and out of the slot.

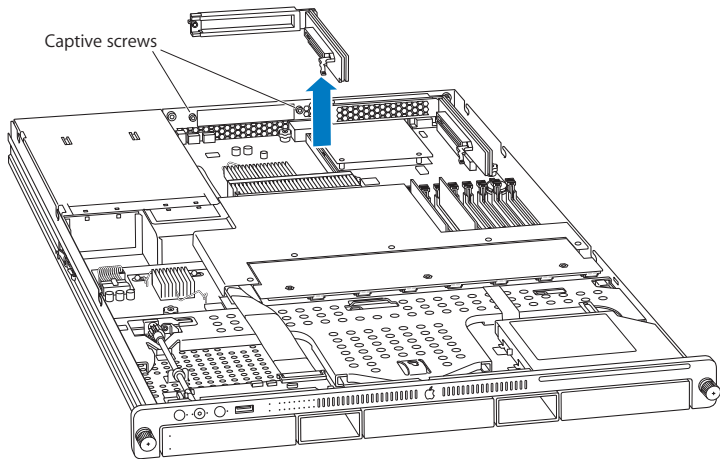

- 4 Remove the screw on the riser bracket, and then remove the port access cover.

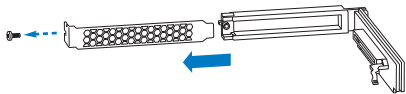

- 5 Seat the PCI card in the riser slot and replace the screw to secure the card in the riser.

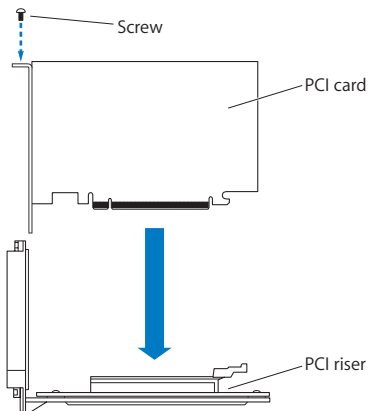

- 6 Align the riser with the slot on the main logic board and press to seat it.

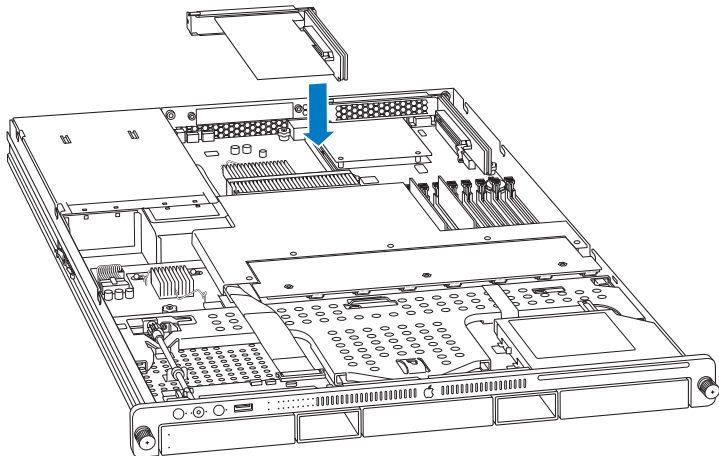

- 7 Tighten the captive screws that secure the riser bracket to the back panel.
- 8 Return the Xserve to the rack and start it up.
- 9 Configure the card.

To configure an Ethernet card, open the Network pane of System Preferences.

To configure a Fibre Channel card, open Fibre Channel Utility.

To configure a SCSI card, open Disk Utility.

Replacing the Battery

The Xserve uses a CR2032 lithium coin cell battery to preserve settings such as the date and time when the system is not connected to power. If the date and time change unexpectedly or other system settings are lost, you might need to replace the battery.

For best results, purchase a replacement battery from an Apple-authorized service provider.

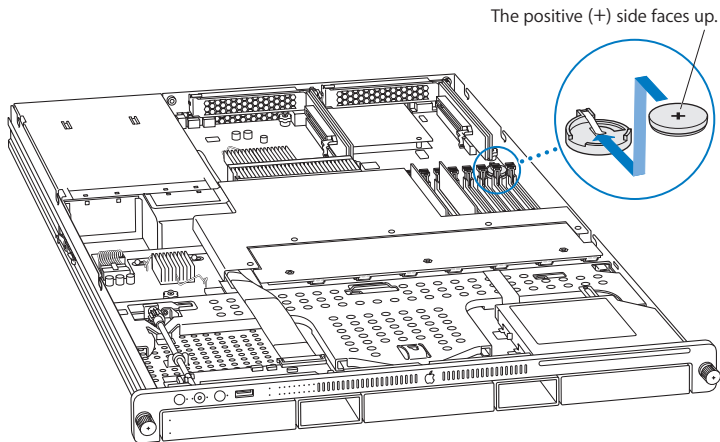

To replace the battery:

- 1 Shut down the Xserve and unplug all cables.

Important: Be sure the Xserve is turned off and the power cords are unplugged before you replace the battery.

- 2 Remove the Xserve from the rack and open it. For instructions, see “Opening and Closing the Xserve” on page 30.



WARNING: Always wait 5 to 10 minutes for the Xserve to cool down before you try to replace the battery. Components near the battery slot may be very hot.

- 3 If you need more room, remove the PCI card in slot 2.
- 4 Remove the old battery by sliding it out of the holder.

WARNING: To avoid risk of explosion, replace the battery only with type CR2032.

- 5 Insert the new battery in the holder with the positive (+) side facing up.
- 6 If you removed a PCI card, replace it.
- 7 Close the Xserve and return it to the rack.

Important: Dispose of the old battery according to the manufacturer’s instructions and your local environmental laws. See the battery disposal information in the Regulatory Compliance Information section at the end of this guide.

Specifications

A

Dimensions

- *Height:* 1.73 in. (4.4 cm) (1U)
- *Width:* 17.6 in. (44.7 cm) for mounting in standard 19-in. rack
- *Depth:* 30 in. (76.2 cm)

Weight

- 31.7 lb. (14.4 kg) with 2 DIMMs, 1 drive module, and 1 power supply
- 38.3 lb. (17.4 kg) with 8 DIMMs, 3 drive modules, and 2 power supplies

Operating Environment

- *Operating temperature:* 50° to 95° F (10° to 35° C)
- *Storage temperature:* -40° to 116° F (-40° to 47° C)
- *Relative humidity:* 5% to 95% (noncondensing)
- *Altitude:* 0 to 10,000 feet (0 to 3048 meters)

Processors

- One or two 2.4 GHz or 3.0 GHz Quad-Core Intel Xeon 5400 processors.
- 12 megabytes (MB) shared cache per processor
- Independent 1.6 gigahertz (GHz) system bus per processor

Random-Access Memory

- 800 MHz DDR2 ECC FB-DIMMs (fully buffered dual inline memory modules with address and data protection using Error-Correcting Code)
- 8 DIMM slots accepting 1 GB, 2 GB, or 4 GB DIMMS in matching pairs for a maximum of 32 GB of SDRAM

Optical Drive

- Slot-loading 8X dual-layer SuperDrive (DVD-RW DL/DVD-RW)
- *Disc types supported:* CD-R RW, DVD-R, DVD-RW, DVD-R DL, and DVD-RW DL
- *Disc dimensions supported:* 4.7 in. (12 cm)

PCI-X and PCI Express Expansion Slot 1

- Accepts an x8 PCI Express or PCI-X 133 MHz card in a matching riser
- Backward compatible with 32-bit and 33/66/100 MHz cards that support 3.3 volt universal signaling
- *Maximum card length:* 6.6 inches (16.7 cm)
- *Maximum power consumption:* 25 Watts

PCI Express Expansion Slot 2

- Accepts an x16 PCI Express 2.0 card in a matching riser
- *Maximum card length:* 9 inches (22.8 cm)
- *Maximum power consumption:* 25 Watts

System Battery

- Long-life CR2032 lithium coin cell battery

Ethernet

- IEEE 802.3 compliant
- *Maximum cable length:* 100 meters (m)
- *Connectors:* RJ-45 for 10Base-T, 100Base-TX, and 1000Base-T
- *Media, 10Base-T:* Category 3 or higher UTP on 2 pairs up to 100 m
- *Media, 100Base-TX:* Category 5 UTP on 2 pairs up to 100 m
- *Media, 1000Base-T:* Category 5 and 6 UTP on 4 pairs up to 100 m
- *Channel speeds:* IEEE Auto Negotiation of 10Base-T, 100Base-TX, and 1000Base-T

FireWire

- *Data transfer speed:* 100, 200, up to 400, and up to 800 megabits per second
- Two FireWire 800 ports

With an appropriate cable, the FireWire ports work with all FireWire devices. Cables are available for connecting a 9-pin port to a 4-pin, 6-pin, or 9-pin device.

- *Output voltage range:* Approximately 12 to 30 V
- *Output power range:* Up to 15 W

USB

- Support for USB 2.0
- Three external Universal Serial Bus (USB) Type A ports
- Separate 480 megabit per second (Mbit/s) USB channel for each port
- 500 milliamperes (mA) at 5 V available per port up to a total of 2.5 ampere (A)
- Any port can supply 1.5 W (the other two ports then supply 500 mW)

Power Supply

- One or two 750 Watt power supplies
- *AC line input*: 100–240 V alternating current (AC), single phase, 50–60 hertz (Hz)
- *Maximum AC line current*: 9A (100–127V) or 4.5A (200–240V); if two power supplies are installed, they split this load

Serial Port

- 9-pin D connector

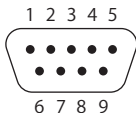

- Pin signals
 - 1: Received line signal detector (RLSD)
 - 2: Received data (RD)
 - 3: Transmitted data (TD)
 - 4: DTE ready (DRT CD)
 - 5: Signal ground (SGND)
 - 6: DCE ready (DCR CC)
 - 7: Request to send (RTS)
 - 8: Clear to send (CTS)
 - 9: Ring indicator (RI)

Important Safety Information

For your own safety and that of your equipment, always take the following precautions.

Important: The only way to shut off power completely is to unplug the power cord. Make sure at least one end of the power cord is within easy reach so that you can unplug the Xserve when you need to.

Disconnect the power plug (by pulling the plug, not the cord) if any of the following conditions exist:

- You want to remove any parts (leave the cord disconnected as long as the cover is off).
- The power cord or plug becomes frayed or otherwise damaged.
- You spill something into the case.
- The Xserve is exposed to rain or any other excessive moisture.
- The Xserve has been dropped or the case has been otherwise damaged.
- You suspect that the Xserve needs service or repair.
- You want to clean the case (use only the recommended procedure described later).

Be sure that you always do the following:

- Keep the Xserve away from sources of liquid, such as washbasins, bathtubs, shower stalls, and so on.
- Protect the Xserve from dampness or wet weather, such as rain and snow.
- Read all the installation instructions carefully before you plug the Xserve into a wall socket or power strip.
- Keep these instructions handy for reference by you and others.
- Follow all instructions and warnings dealing with the Xserve.

Electrical equipment may be hazardous if misused.

The model of server described in this manual is certified only as a component for use with other equipment, where the suitability of the combination has been determined by a Nationally Recognized Testing Laboratory.

Handling the Xserve

Follow these guidelines for handling the Xserve and its components:

WARNING: Do not put a display or any other device on top of the Xserve. Extra weight can strain your rack's rails, which can make your rack unstable. If your rack is unstable, the Xserve and whatever is on top of it can fall on you. Also, any weight on top of the case could damage essential components inside the Xserve.

- When the Xserve is removed from the rack, set it on a sturdy, flat surface.
- When connecting or disconnecting a cable, always hold the cable by its connector (the plug, not the cord).

- Certain components and cables—hard disks, a VGA monitor, FireWire, Ethernet, and USB devices—are designed to be installed or removed while the Xserve is turned on and operating.
- Never force a connector into a port. If the connector and port do not join with reasonable ease, they probably don't match. Make sure that the connector matches the port and that you have positioned the connector correctly in relation to the port.
- Take care not to spill any food or liquid on the Xserve or other components. If you do, turn off the Xserve immediately and unplug it before cleaning up the spill. Arrange for an Apple-authorized service provider to inspect or repair the Xserve.
- Protect the Xserve and its components from direct sunlight and rain or other moisture.
- Keep all ventilation openings clear and unobstructed. Without proper air circulation, components can overheat, causing damage or unreliable operation.

Protecting the Optical Drive

To keep the optical drive working properly:

- In an emergency, you can eject a disc by holding down the mouse button as the system starts up. If no mouse is attached, you can eject the disc by using the front panel controls to start up from the optical drive; for instructions, see the *Xserve User's Guide* on the *Admin Tools and Xserve Diagnostics* CD.

You may want to take out the disc before shutting down.

Power Supply

The power supply in the Xserve is a high-voltage component that should not be opened for any reason, even when the computer is off. If the power supply needs service, contact your Apple-authorized dealer or Apple Authorized Service Provider.

Cleaning the Xserve

Follow these general rules when cleaning the outside of the Xserve:

- Use a damp, soft, lint-free cloth to clean the exterior. Avoid getting moisture in any openings.
- Don't use aerosol sprays, solvents, or abrasives.

Cleaning the Xserve Case

To clean the case, do the following:

- 1 Turn off the computer completely and then disconnect the power plug (pull the plug, not the cord).
- 2 Wipe the surfaces lightly with a clean, soft cloth dampened with water.

Apple and the Environment

Apple recognizes its responsibility to minimize the environmental impacts of its operations and products.

For More Information

Go to www.apple.com/about/environment.

Health-Related Information About Computer Use

In most instances, you will probably set up and administer the Xserve from a remote location, such as an administrator computer on the same network. If you work at the server rack for extended periods, be sure to following these guidelines for avoiding muscle soreness, eye fatigue, or other discomfort associated with computer use.

- If feasible, at the server location use an adjustable chair that provides firm, comfortable support. The back of the chair should support your lower back (lumbar region). Follow the manufacturer's instructions for adjusting the backrest to fit your body properly.
- When using a keyboard at the server location, your shoulders should be relaxed. Your upper arm and forearm should form an approximate right angle, with your wrist and hand roughly in a straight line. Depending on the location of the display and keyboard connected to the Xserve, you may have to adjust the height of your chair so that you can maintain a comfortable position. Your feet should be flat on the floor or on a footrest.

Regulatory Compliance Information

FCC Compliance Statement

This equipment has been tested and found to comply with the limits for a class A digital device pursuant to Part 15 of the FCC Rules. These limits are designed to provide reasonable protection against harmful interference when the equipment is operated in a commercial environment. This equipment generates, uses, and can radiate radio frequency energy and, if not installed and used in accordance with the manufacturer's instruction manual, may cause harmful interference with radio communications. Operation of this equipment in a residential area is likely to cause harmful interference, in which case you will be required to correct the interference at your own expense.

Shielded Cable Statement & Modification Statement

This product was tested for EMC compliance under conditions that included the use of Apple peripheral devices and Apple shielded cables and connectors between system components. It is important that you use Apple peripheral devices and shielded cables and connectors between system components to reduce the possibility of causing interference to radios, television sets, and other electronic devices. You can obtain Apple peripheral devices and the proper shielded cables and connectors through an Apple-authorized dealer. For non-Apple peripheral devices, contact the manufacturer or dealer for assistance.

Important: Changes or modifications to this product not authorized by Apple Inc. could void the EMC compliance and negate your authority to operate the product.

Industry Canada Statement

Complies with the Canadian ICES-003 Class A specifications. Cet appareil numérique de la classe A est conforme à la norme NMB-003 du Canada.

Statement for Norway

Dette utstyret har blitt evaluert og er egnet for bruk på et IT-Power-system.

Statement for Germany

Das Produkt ist nicht für den Einsatz an Bildschirmarbeitsplätzen im Sinne § 2 der Bildschirmarbeitsplatzverordnung geeignet.

Die arbeitsplatzbezogene Geräuschemission des Gerätes beträgt <70 dB(A).

VCCI Class A Statement

この装置は、情報処理装置等電波障害自主規制協議会（VCCI）の基準に基づくクラスA情報技術装置です。この装置を家庭環境で使用すると電波妨害を引き起こすことがあります。この場合には使用者が適切な対策を講ずるよう要求されることがあります。

CISPR 22 & EN55022 Statement

WARNING: This is a Class A product. In a domestic environment this product may cause radio interference, in which case the user may be required to take adequate measures.

Taiwan Class A Warning

警告使用者：
這是甲類的資訊產品，在居住的環境中使用時，可能會造成射頻干擾，在這種情況下，使用者會被要求採取某些適當的對策。

Korea Class A Warning

기종별	사용자 안내문
A급기기	이 기기는 업무용으로 전자파적합등록을 한 기기로서 판매자 또는 사용자들이 점을 주의하시기 바라며 만약 잘못된 판매 또는 구입하였을 경우에는 가정용으로 교환하시기 바랍니다.

China Class A Warning

声明
此为A级产品，在生活环境中，该产品可能会造成无线电干扰，在这种情况下，可能需要用户对其干扰采取切实可行的措施。

Laser Information

WARNING: Making adjustments or performing procedures other than those specified in your equipment's manual may result in hazardous radiation exposure.

Do not attempt to disassemble the cabinet containing the laser. The laser beam used in this product is harmful to the eyes. The use of optical instruments, such as magnifying lenses, with this product increases the potential hazard to your eyes. For your safety, have this equipment serviced only by an Apple-authorized service provider.

If you have an internal Apple CD-ROM, DVD-ROM, or DVD-RAM drive in your computer, your computer is a Class 1 laser product. The Class 1 label, located in a user-accessible area, indicates that the drive meets minimum safety requirements. A service warning label is located in a service-accessible area. The labels on your product may differ slightly from the ones shown here.



Class 1 label



Service warning label

High-Risk Activities Warning

This computer system is not intended for use in the operation of nuclear facilities, aircraft navigation or communications systems, or air traffic control machines, or for any other uses where the failure of the computer system could lead to death, personal injury or severe environmental damage.

中国

有毒或有害物质	零部件			
	电路板	硬盘驱动器	电池组	附件
铅 (Pb)	X	X	X	X
汞 (Hg)	0	0	0	0
镉 (Cd)	0	0	0	0
六价铬 (Cr, VI)	0	0	0	0
多溴联苯 (PBB)	0	0	0	0
多溴二苯醚 (PBDE)	0	0	0	0

O: 表示该有毒有害物质在该部件所有均质材料中的含量均在 SJ/T 11363-2006 规定的限量要求以下。

X: 表示该有毒有害物质至少在该部件的某一均质材料中的含量超出 SJ/T 11363-2006 规定的限量要求。

根据中国电子行业标准 SJ/T11364-2006 和相关的中国政府法规，本产品及其某些内部或外部组件上可能带有环保使用期限标识。取决于组件和组件制造商，产品及其组件上的使用期限标识可能有所不同。组件上的使用期限标识优先于产品上任何与之相冲突的或不同的环保使用期限标识。

Disposal and Recycling Information

Dispose of your Xserve and its battery according to your local environmental laws and guidelines.

For information about Apple's recycling program, go to www.apple.com/environment.

European Union



The symbol above means that according to local laws and regulations your product should be disposed of separately from household waste. When this product reaches its end of life, take it to a collection point designated by local authorities. Some collection points accept products for free. The separate collection and recycling of your product at the time of disposal will help conserve natural resources and ensure that it is recycled in a manner that protects human health and the environment.

Battery Disposal Information

When replacing the internal battery, dispose of the spent battery according to your local environmental laws and guidelines.

California: The coin cell battery in your Xserve contains perchlorates. Special handling and disposal may apply. Refer to www.dtsc.ca.gov/hazardouswaste/perchlorate.

Nederlands: Gebruikte batterijen kunnen worden ingeleverd bij de chemokar of in een speciale batterijcontainer voor klein chemisch afval (kca) worden gedeponeerd.



Deutschland: Das Gerät enthält Batterien. Diese gehören nicht in den Hausmüll. Sie können verbrauchte Batterien beim Handel oder bei den Kommunen unentgeltlich abgeben. Um Kurzschlüsse zu vermeiden, kleben Sie die Pole der Batterien vorsorglich mit einem Klebestreifen ab.

Taiwan:



廢電池請回收

Apple and the Environment

Apple recognizes its responsibility to minimize the environmental impacts of its operations and products.

More information is available on the web:
www.apple.com/environment