



iPhone 5c

Apple Recycler Guide

June 2023

Contents

3	About This Guide
4	Identification
5	Directive 2012/19/EU Annex VII Components
6	Safety Considerations
8	Recommended Tools
9	Disassembly Instructions
28	Material Categorization of Output Fractions

About This Guide

Apple Recycler Guides provide guidance for electronics recyclers on how to disassemble products to maximize recovery of resources. The guides provide step-by-step disassembly instructions and information on the material composition to help recyclers direct fractions to the appropriate material recycler.

To conserve important resources, we work to reduce the materials we use and aim to one day source only recycled or renewable materials in our products. A key path to reaching that goal is resource recovery from end-of-life electronics.

Disassembly procedures are intended to be performed only by trained electronics recycling professionals. The recycler is responsible for independently evaluating and ensuring compliance with all applicable environmental, health, and safety laws related to the work. These include but are not limited to laws relating to the management, handling, shipping, and disposal of the outputs of this work as waste and laws in place to ensure the health and safety of all employees who support this work.

For questions or feedback about this guide, email contactesci@apple.com.

Identification

You can find the model number on the back of the iPhone 5c.

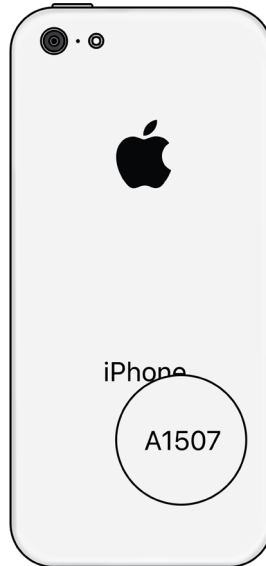

Model numbers:
A1456, A1507, A1516, A1529, A1532

Directive 2012/19/EU Annex VII Components

Directive 2012/19/EU Annex VII requirements apply to the following substances and components.

Substance/Component	Apple Part Name	Removal Instructions
Printed circuit board if the surface is greater than 10 square centimeters	Main logic board	Follow steps 1–17
External electric cables	Power adapter, charge cable	Follow step 1
Battery	Lithium-ion polymer battery	Follow steps 1–9
Cover glass and liquid crystal display (LCD) cell if the surface is greater than 100 square centimeters	LCD cell	Follow steps 1–8
No further substances or components as listed in Annex VII		

Safety Considerations

The recycler is responsible for independently evaluating all activities undertaken by its employees to perform or support the work and ensuring compliance with all applicable health and safety laws related to the work. These include but are not limited to laws relating to the health and safety of all employees who perform or support this work. The recycler is also responsible for evaluating the workspace and ensuring that the area in which the work is to be undertaken is designed using ergonomic best practices and meets all ergonomic requirements to ensure the protection of its employees.

Personal Protective Equipment

Personal protective equipment should be worn during the entire recycling process.



Wear hand protection



Wear protective clothing



Wear eye protection



Wear foot protection

Battery Safety

This product uses a lithium-ion polymer battery. Before beginning any disassembly work, ensure that a safe working procedure for handling lithium-ion batteries has been established, which could include discharging the batteries so that they can be more safely managed. The following considerations may also be included:

- Remove anything from your person that could conduct energy, such as jewelry and watches, to avoid electric shock to yourself or the logic board.
- To avoid the potential for thermal runaway and the release of potentially noxious fumes, don't puncture, strike, or crush lithium-ion polymer batteries or devices powered by them.
- Don't throw, drop, or bend the battery.
- Don't expose the battery to excessive heat or sunlight.
- Don't use tools that are sharp or conduct electricity.
- Keep your workspace clear of foreign objects and sharp materials.
- Dispose of batteries according to local environmental laws and guidelines.

Workspace safety guidelines

- Use heat-resistant gloves and safety glasses.
- Keep a sand dispenser within arm's reach (2 feet or 0.6 m) on one side of the workstation, not above the workstation. The dispenser should be a wide-mouthed, quick-pour metal container with a flip-top lid or tray that contains 8–10 cups (1.9–2.4 L) of clean, dry, untreated sand.
- Keep the battery at least 2 feet (0.6 m) from paper and other combustible materials.
- Work in an area with adequate ventilation.

Handling a thermal runaway

If you notice any of the following signs, a thermal runaway is likely underway, and you should act immediately:

- The lithium-ion polymer battery or a device containing one begins to smoke or emit sparks or soot.
- The battery pouch suddenly and quickly puffs out.
- You hear hissing or popping sounds.

Don't use water or an ABC/CO₂ fire extinguisher on a thermal runaway battery or a device containing one. Water and ABC/CO₂ fire extinguishers will not stop the reaction.

Do smother the battery or device immediately with plenty of clean, dry sand, dumped all at once. Timing is critical; the faster you pour all the sand, the faster the thermal runaway will stop.

Do leave the room for 30 minutes if the thermal runaway causes any irritation.

Do wait 30 minutes before touching the battery. Wear heat-resistant gloves and safety glasses to remove the battery from the sand, or use a touchless thermometer to measure the battery temperature. Only touch the battery when the event has finished.

Do dispose of the damaged battery or device (including any debris removed from the sand) according to local environmental laws and guidelines.

Hazard Warnings



Broken glass hazard



Rechargeable battery hazard



Chemical exposure hazard

Recommended Tools

Flat-blade screwdriver

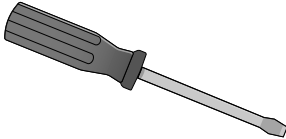

Miniature plastic pry bar

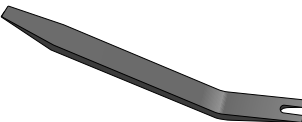

Miniature pry bar

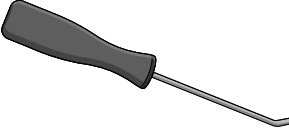

Nail-pulling screwdriver

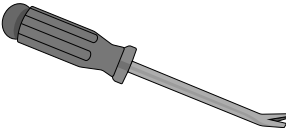

Tweezers



Disassembly Instructions

1. Remove the power adapter and the charge cable.

- » *Ensure that the iPhone is turned off.*
- » *Unplug the power adapter. Disconnect both ends of the charge cable.*

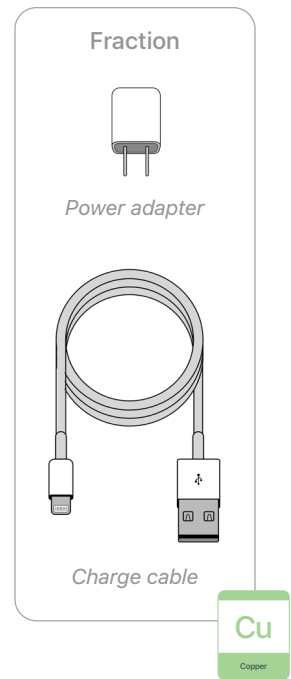

2. Remove the display.



Broken glass hazard



Chemical exposure hazard

Tools Used

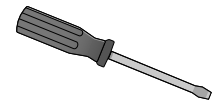

- » *Hold the iPhone at the edge of a counter with the display face up and the Lightning connector toward the counter edge.*
- » *Insert the tool tip into the Lightning connector. Push the handle down to pry the display from the enclosure.*

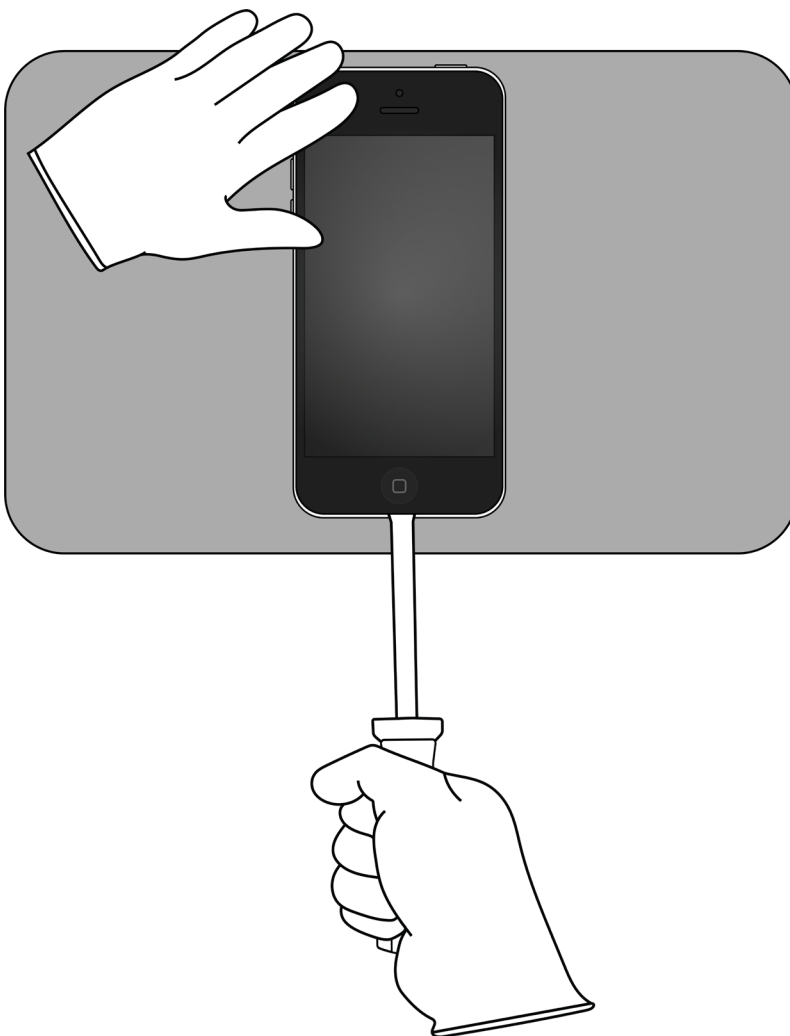

- » *Remove the display by hand. Set the enclosure aside.*

- 3.** With the display facing down, pry off the front camera cover.

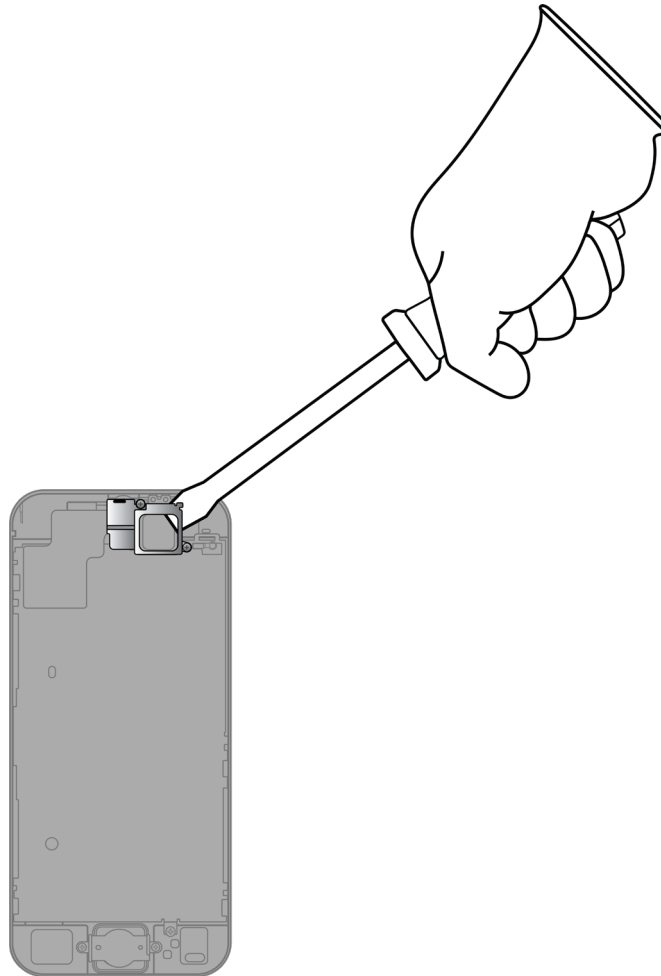

Tools Used

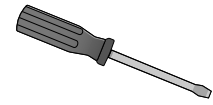

Fraction

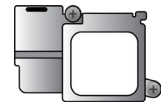

Front camera cover

Fe

Ferrous

4. Pry off the receiver.

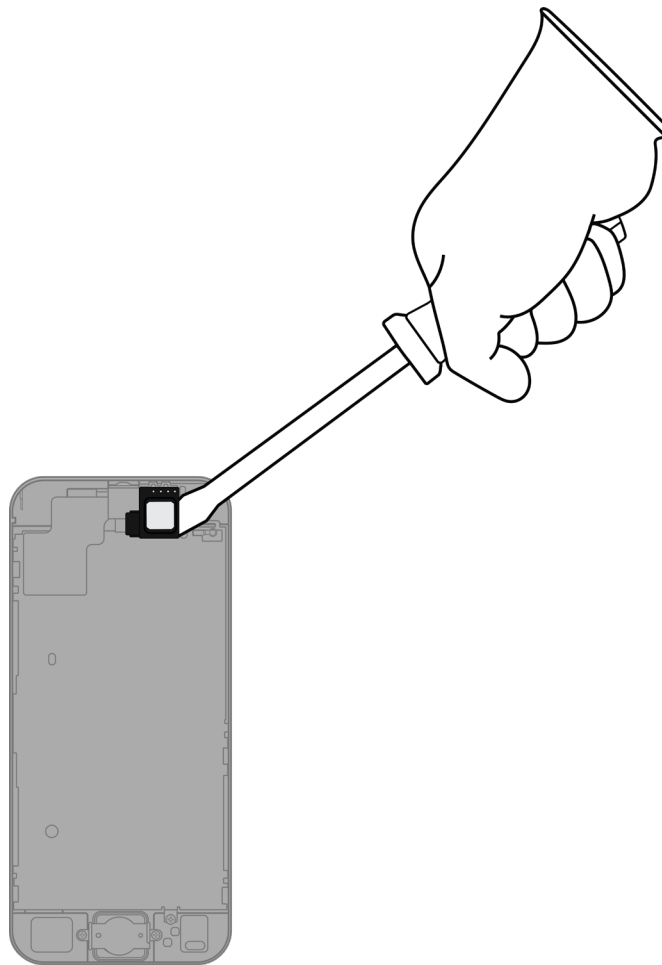

Tools Used

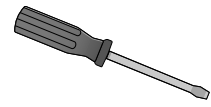

Fraction

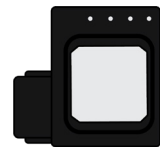

Receiver



5. Pry off the front camera.

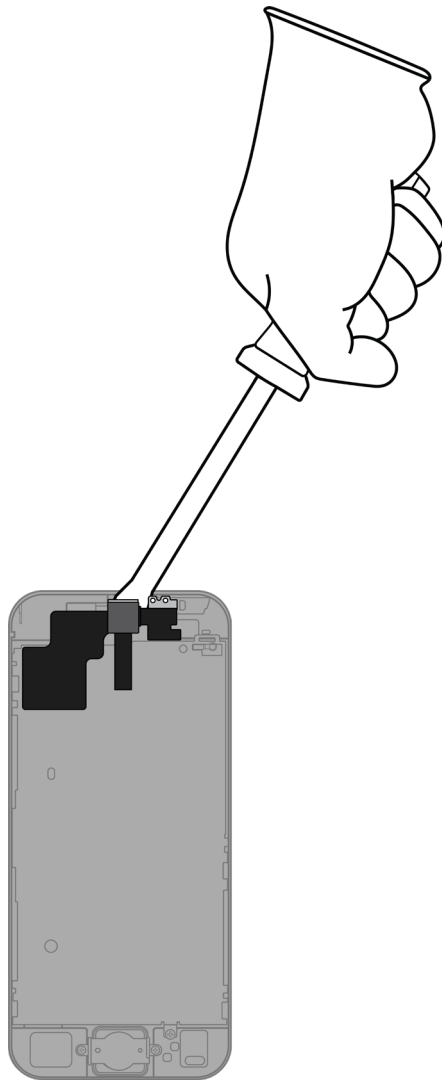

Tools Used

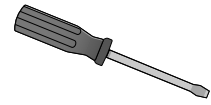

Fraction



Front camera



6. Pry off the Home button cover.

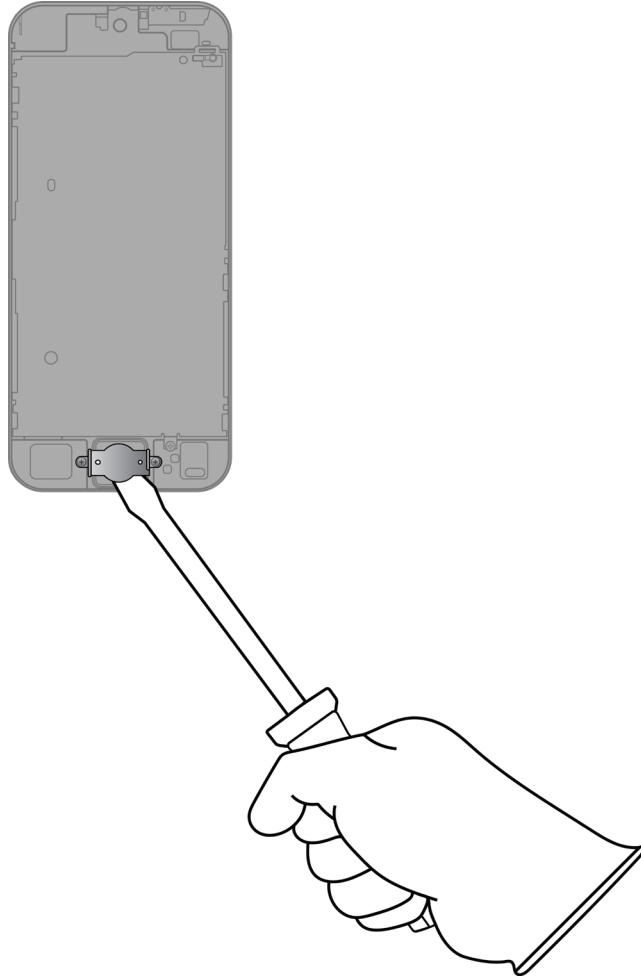

Tools Used

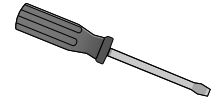

Fraction

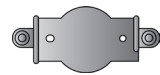

Home button cover

Fe

Ferrous

7. Pry off the Home button.

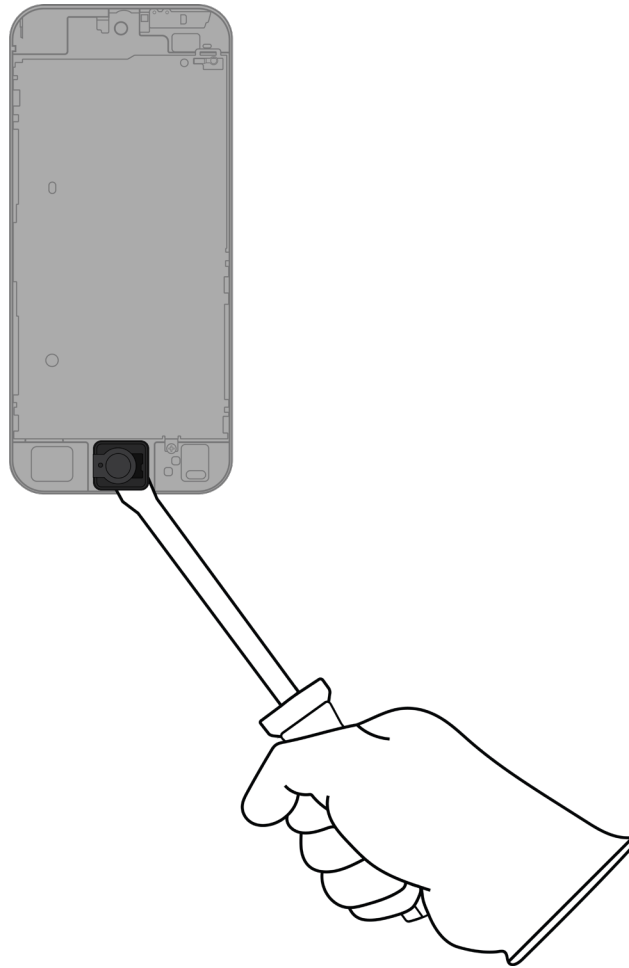

Tools Used

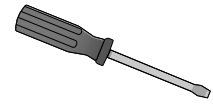

Fraction



Home button

Cu

Copper

8. Pry off the display cover.

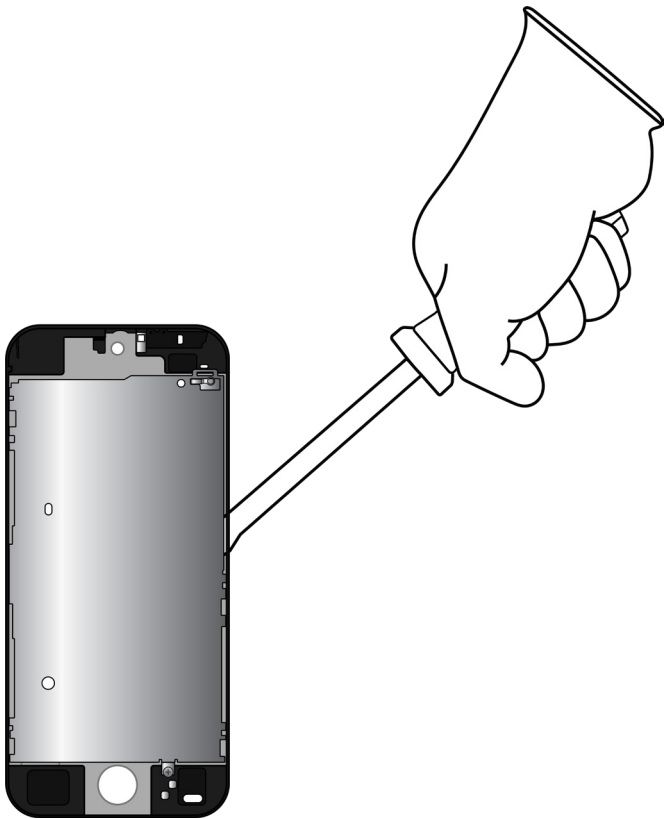

Tools Used



Fraction



Display cover

Fe

Ferrous

Fraction



LCD cell

GL

Glass

9. Inside the enclosure, carefully remove the lithium-ion polymer battery.

 Rechargeable battery hazard

- » *Using tweezers, gently peel one of the black battery adhesive tabs away from the battery.*
- » *Twist the tab around the tweezers until white adhesive appears. Continue twisting until the entire adhesive strip is removed.*
- » *Repeat this process for the remaining battery tabs. Continue with the miniature plastic pry bar if needed.*

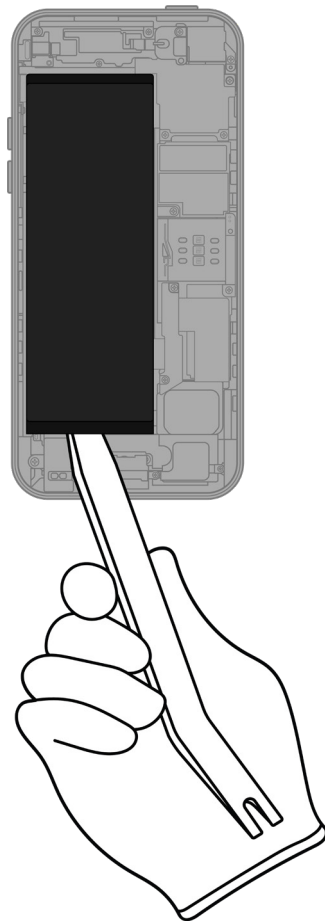

Tools Used



Fraction



Lithium-ion polymer battery



10. Pry off the vibration motor.

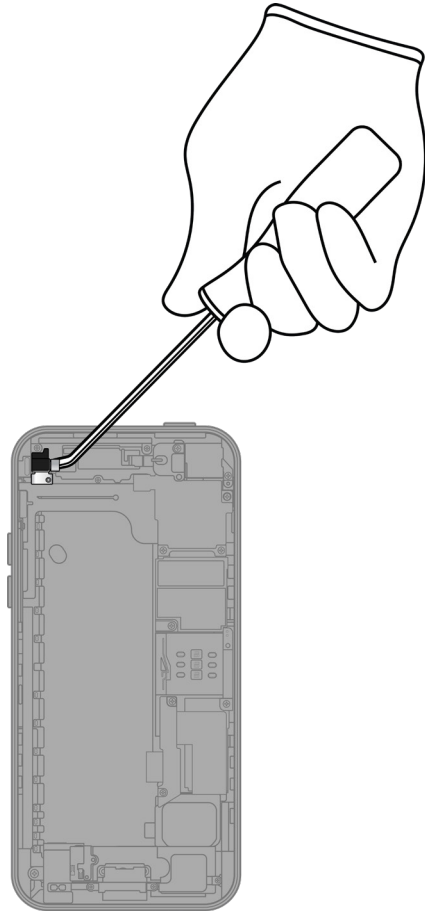

Tools Used



Fraction

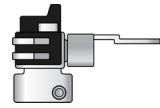

Vibration motor

Cu

Copper

11. Pry off the rear camera cover.

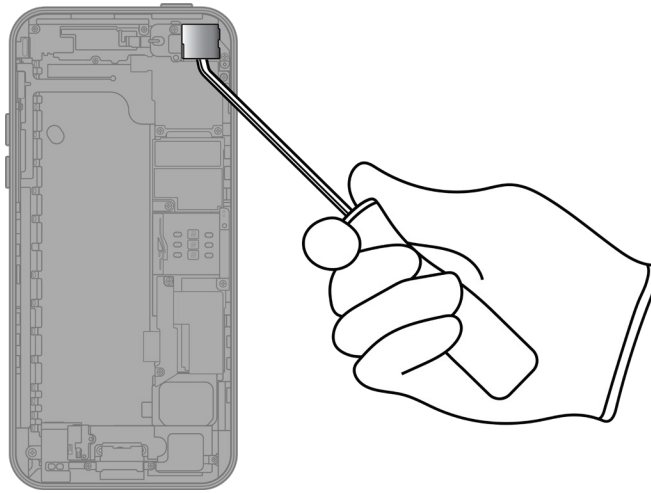

Tools Used



Fraction



Rear camera cover

Fe

Ferrous

12. Pry off the rear camera.

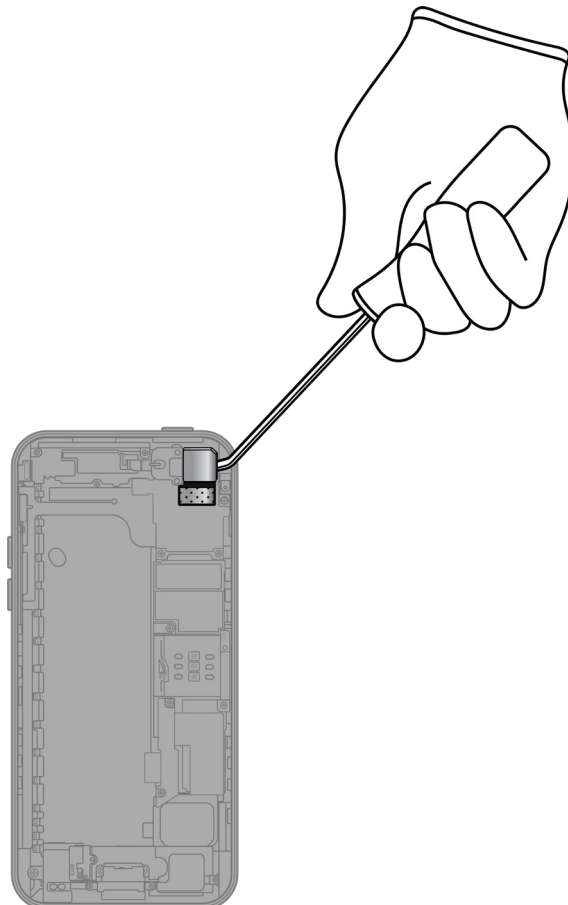

Tools Used



Fraction



Rear camera

PMs

Precious
Metals

13. Pry off the strobe cover.

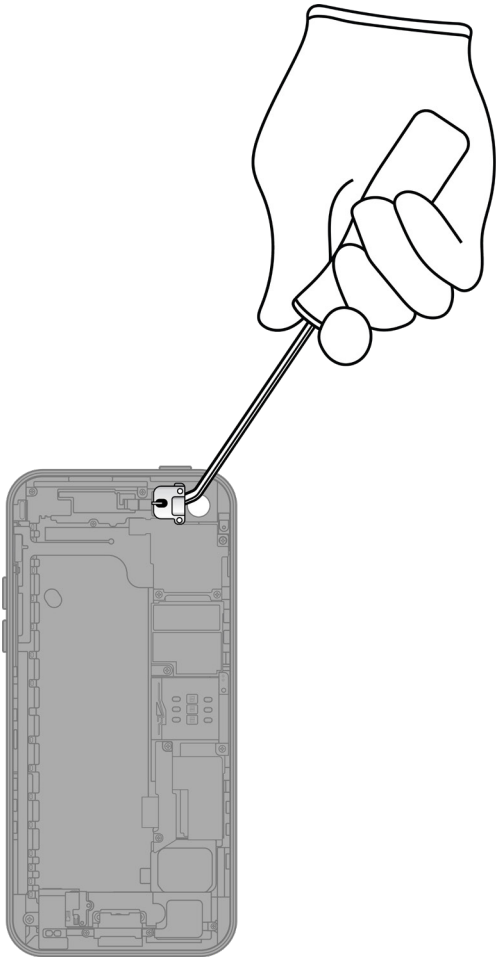

Tools Used



Fraction



Strobe cover

Fe

Ferrous

14. Pry off the microphone.

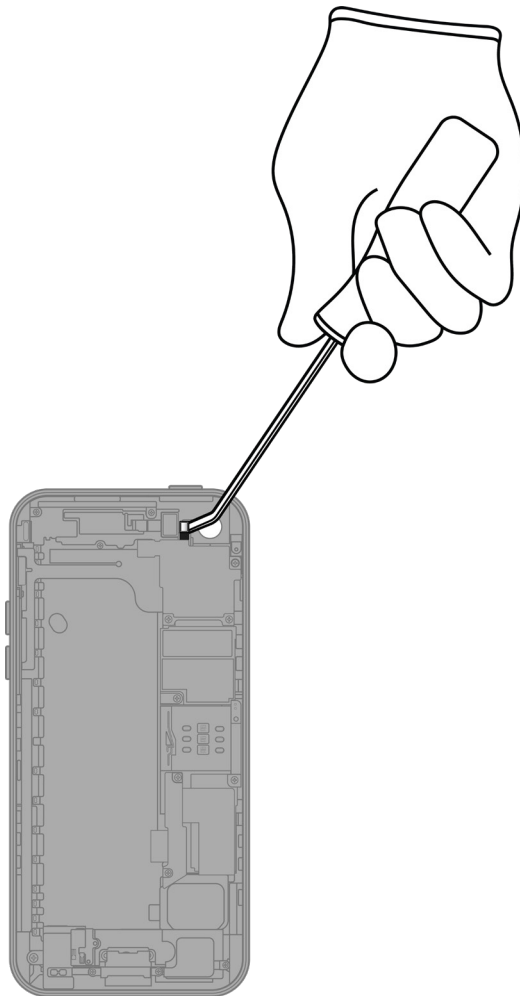

Tools Used



Fraction



Microphone

Cu

Copper

15. Pry off the strobe.

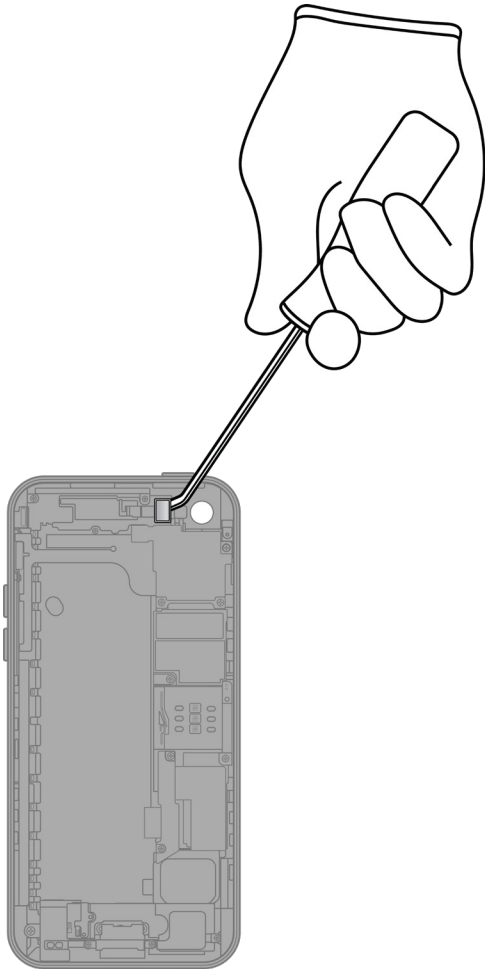

Tools Used



Fraction



Strobe

Cu

Copper

- 16.** Remove the SIM tray. Separate the SIM card from the SIM tray.

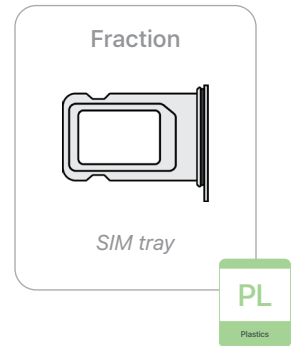
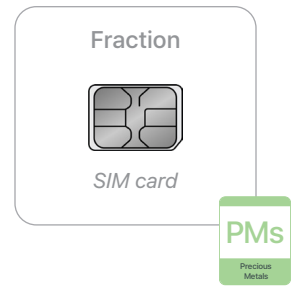
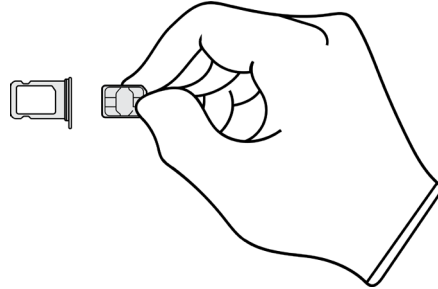
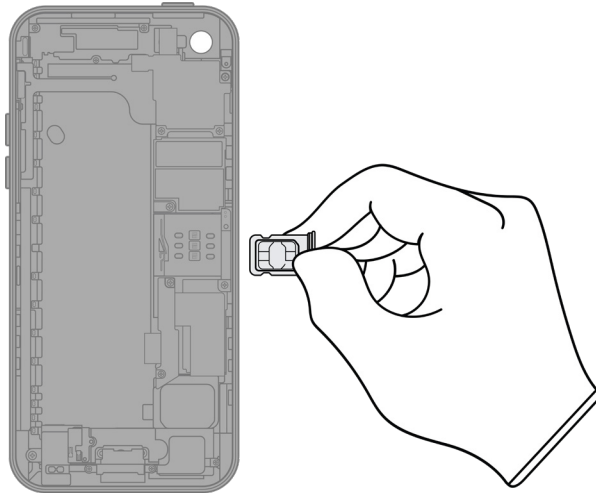

17. Pry off the main logic board.

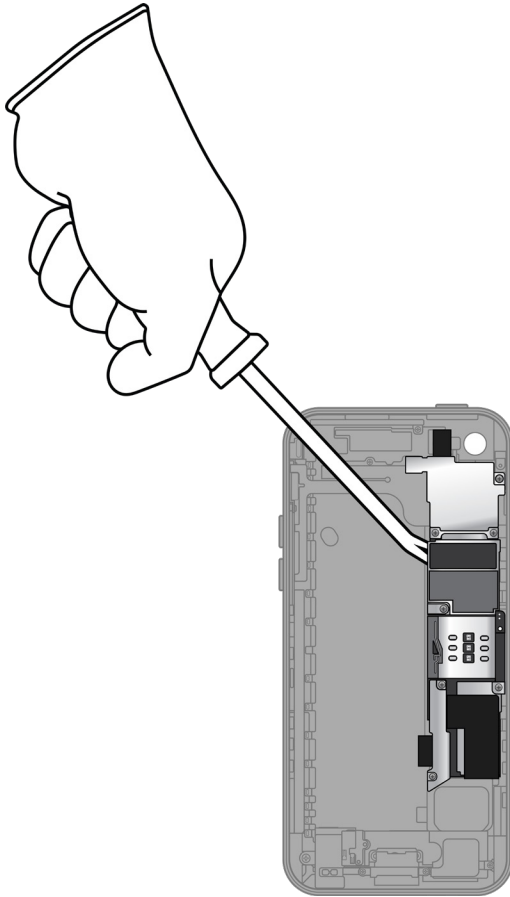

Tools Used

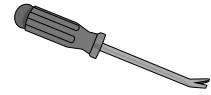

Fraction



Main logic board

PMs
Precious
Metals

18. Pry off the speaker.

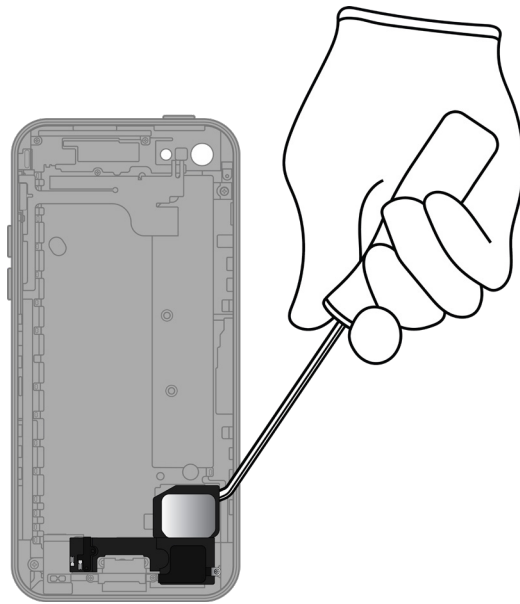

Tools Used



Fraction

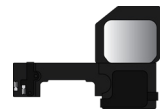

Speaker

REE
Rare Earth
Elements

19. Pry off the headphone jack.

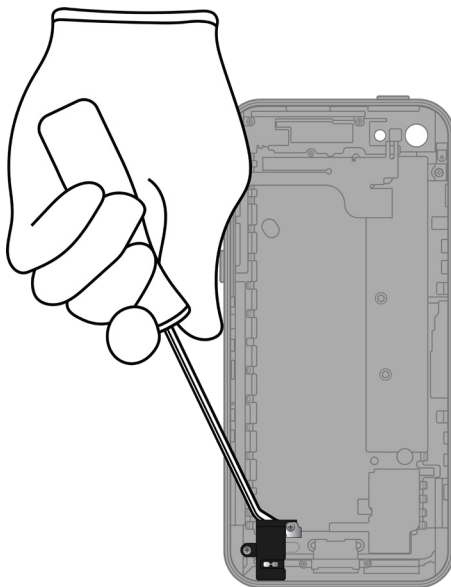

Tools Used



Fraction



Headphone jack

Cu
Copper

20. Pry off the Lightning connector.

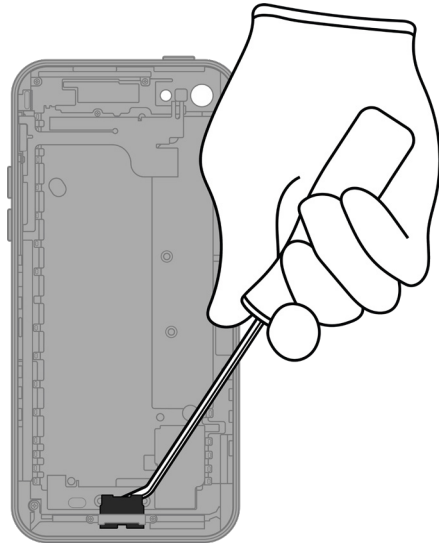

Tools Used



Fraction



Lightning connector

Cu

Copper

21. Remove the ribbon cables.

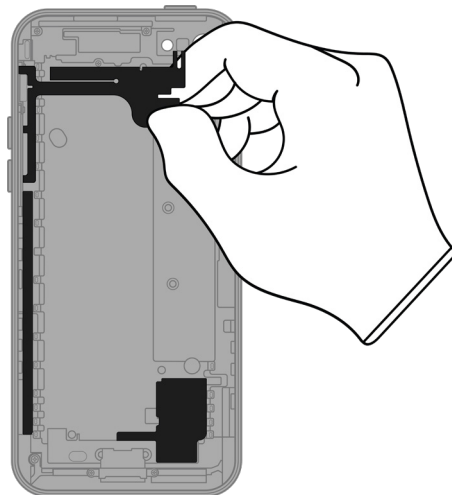

Fraction



Ribbon cables

Cu

Copper

22. Pry the enclosure out of its cover.



Tools Used



Fraction

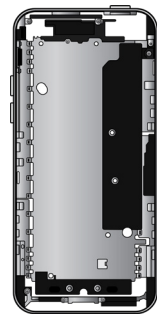

Enclosure

Fe

Ferrous

Fraction

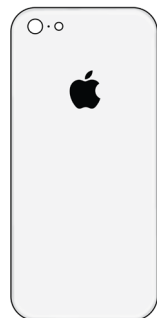







Enclosure cover

PL

Plastics

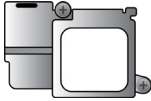
Material Categorization of Output Fractions

All outputs from this process must be managed, handled, and disposed of in accordance with applicable waste laws and regulations, including but not limited to the Waste Framework Directive and its national enactments in Europe.

Fraction	Downstream Processing
<p data-bbox="440 604 565 636">Batteries</p>  <p data-bbox="367 936 636 961"><i>Lithium-ion polymer battery</i></p>	<p data-bbox="966 604 1276 636">Primary Target Material</p> 
<p data-bbox="448 1058 557 1089">Ferrous</p>  <p data-bbox="407 1245 596 1270"><i>Front camera cover</i></p>  <p data-bbox="407 1398 596 1423"><i>Home button cover</i></p>  <p data-bbox="435 1808 568 1833"><i>Display cover</i></p>	<p data-bbox="966 1058 1276 1089">Primary Target Material</p>  <p data-bbox="927 1285 1317 1316">Potential Additional Materials</p> 

Fraction

Downstream Processing

Ferrous (cont.)



Rear camera cover

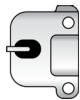

Strobe cover

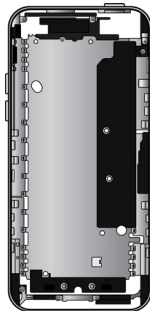

Enclosure

Glass



LCD cell

Primary Target Material



Potential Additional Materials



Fraction

Downstream Processing

Logic Boards

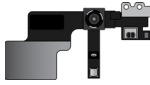

Front camera



Rear camera



SIM card

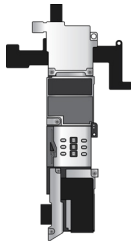

Main logic board

Primary Target Material



Potential Additional Materials



Fraction

Downstream Processing

Mixed Electronics



Power adapter

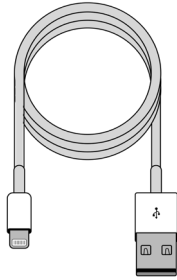

Charge cable



Home button

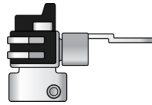

Vibration motor



Microphone



Strobe

Primary Target Material



Potential Additional Materials



Mixed Electronics (cont.)



Headphone jack



Lightning connector



Ribbon cables

Mixed Plastics

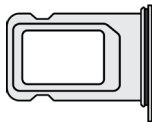

SIM tray



Enclosure cover

Primary Target Material



Fraction

Downstream Processing

Rare Earth Magnets

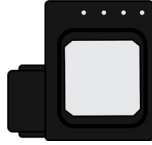

Receiver

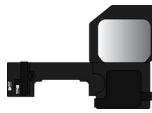

Speaker

Primary Target Material



Potential Additional Materials

