



**iPad Wi-Fi**

**iPad Wi-Fi + 3G**

# Apple Recycler Guide

April 2023

# Contents

3	<a href="#">About This Guide</a>
4	<a href="#">Identification</a>
5	<a href="#">Directive 2012/19/EU Annex VII Components</a>
6	<a href="#">Safety Considerations</a>
8	<a href="#">Recommended Tools</a>
9	<a href="#">Disassembly Instructions</a>
26	<a href="#">Material Categorization of Output Fractions</a>

# About This Guide

Apple Recycler Guides provide guidance for electronics recyclers on how to disassemble products to maximize recovery of resources. The guides provide step-by-step disassembly instructions and information on the material composition to help recyclers direct fractions to the appropriate material recycler.

To conserve important resources, we work to reduce the materials we use and aim to one day source only recycled or renewable materials in our products. A key path to reaching that goal is resource recovery from end-of-life electronics.

Disassembly procedures are intended to be performed only by trained electronics recycling professionals. The recycler is responsible for independently evaluating and ensuring compliance with all applicable environmental, health, and safety laws related to the work. These include but are not limited to laws relating to the management, handling, shipping, and disposal of the outputs of this work as waste and laws in place to ensure the health and safety of all employees who support this work.

For questions or feedback about this guide, email [contactesci@apple.com](mailto:contactesci@apple.com).

**Note:** This guide may show images from other similar models, but the procedures are the same.

# Identification

You can find the model number on the back of the iPad.



*Model numbers:  
(Wi-Fi) A1219  
(Wi-Fi + 3G) A1337*

# Directive 2012/19/EU Annex VII Components

Directive 2012/19/EU Annex VII requirements apply to the following substances and components.

Substance/Component	Apple Part Name	Removal Instructions
Printed circuit board if the surface is greater than 10 square centimeters	Display logic board, main logic board	Follow steps 1–11
External electric cables	Power adapter, charge cable	Follow step 1
Battery	Lithium-ion polymer batteries	Follow steps 1–10
Cover glass and liquid crystal display (LCD) cell if the surface is greater than 100 square centimeters	LCD cell, cover glass	Follow steps 1–7
No further substances or components as listed in Annex VII		

# Safety Considerations

The recycler is responsible for independently evaluating all activities undertaken by its employees to perform or support the work and ensuring compliance with all applicable health and safety laws related to the work. These include but are not limited to laws relating to the health and safety of all employees who perform or support this work. The recycler is also responsible for evaluating the workspace and ensuring that the area in which the work is to be undertaken is designed using ergonomic best practices and meets all ergonomic requirements to ensure the protection of its employees.

## Personal Protective Equipment

Personal protective equipment should be worn during the entire recycling process.



Wear hand protection



Wear protective clothing



Wear eye protection



Wear foot protection

## Battery Safety

This product uses a lithium-ion polymer battery. Before beginning any disassembly work, ensure a safe working procedure for handling lithium-ion batteries has been established, which could include discharging the batteries so that they can be more safely managed. The following considerations may also be included:

- Remove anything from your person that could conduct energy, such as jewelry and watches, to avoid electric shock to yourself or the logic board.
- To avoid the potential for thermal runaway and the release of potentially noxious fumes, don't puncture, strike, or crush lithium-ion polymer batteries or devices powered by them.
- Don't throw, drop, or bend the battery.
- Don't expose the battery to excessive heat or sunlight.
- Don't use tools that are sharp or conduct electricity.
- Keep your workspace clear of foreign objects and sharp materials.
- Dispose of batteries according to local environmental laws and guidelines.

## Workspace safety guidelines

- Use heat-resistant gloves and safety glasses.
- Keep a sand dispenser within arm's reach (2 feet or 0.6 m) on one side of the workstation, not above the workstation. The dispenser should be a wide-mouthed, quick-pour metal container with a flip-top lid or tray that contains 8–10 cups (1.9–2.4 L) of clean, dry, untreated sand.
- Keep the battery at least 2 feet (0.6 m) from paper and other combustible materials.
- Work in an area with adequate ventilation.

## Handling a thermal runaway

If you notice any of the following signs, a thermal runaway is likely underway, and you should act immediately:

- The lithium-ion polymer battery or a device containing one begins to smoke or emit sparks or soot.
- The battery pouch suddenly and quickly puffs out.
- You hear hissing or popping sounds.

**Don't** use water or an ABC/CO<sub>2</sub> fire extinguisher on a thermal runaway battery or a device containing one. Water and ABC/CO<sub>2</sub> fire extinguishers will not stop the reaction.

**Do** smother the battery or device immediately with plenty of clean, dry sand, dumped all at once. Timing is critical; the faster you pour all the sand, the faster the thermal runaway will stop.

**Do** leave the room for 30 minutes if the thermal runaway causes any irritation.

**Do** wait 30 minutes before touching the battery. Wear heat-resistant gloves and safety glasses to remove the battery from the sand, or use a touchless thermometer to measure the battery temperature. Only touch the battery when the event has finished.

**Do** dispose of the damaged battery or device (including any debris removed from the sand) according to local environmental laws and guidelines.

## Hazard Warnings



Broken glass hazard



Rechargeable battery hazard



Chemical exposure hazard

# Recommended Tools

Miniature pry bar

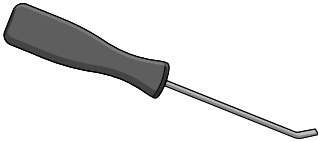

Nail-pulling screwdriver

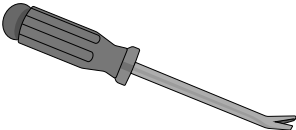

Plastic pry bar

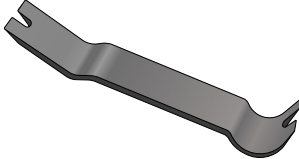

Screwdriver-handle pry bar

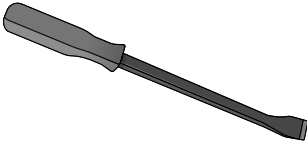



# Disassembly Instructions

## 1. Remove the power adapter and the charge cable.

- » *Ensure that the iPad is turned off.*
- » *Unplug the power adapter. Disconnect both ends of the charge cable.*

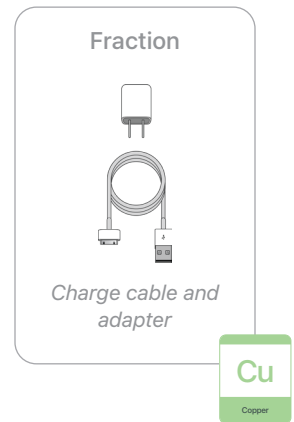

## 2. Separate the display from the enclosure.



Broken glass hazard



Chemical exposure hazard

- » *Hold the iPad at the edge of a counter with the display faceup.*
- » *Insert the tool tip into the Home button. Push the handle down to pry the display from the enclosure.*
- » *Remove the display by hand. Set the enclosure aside.*

### Tools Used

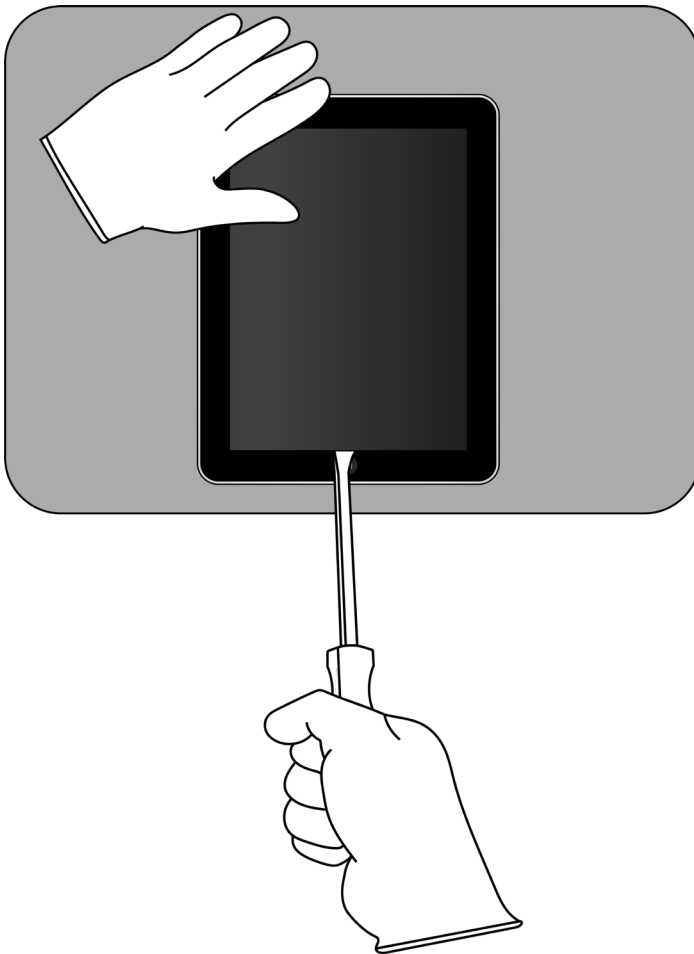

3. With the display facedown, pry off the display logic board.

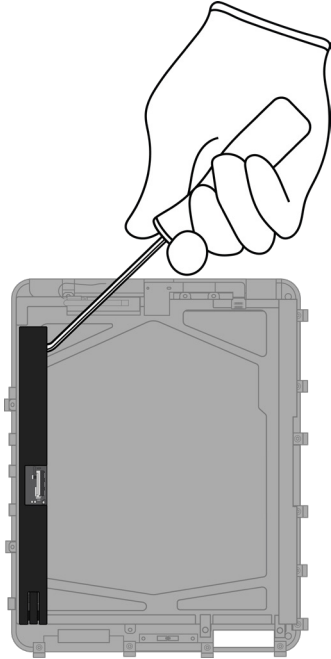

Tools Used



Fraction



Display logic board

PMs  
Precious  
Metals

4. Pull off the light sensor.

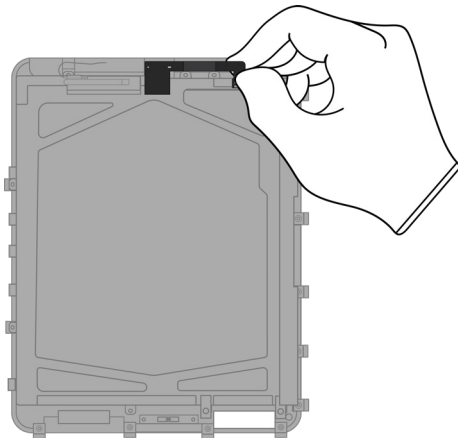

Fraction



Light sensor

Cu  
Copper

**5.** Pry off the antenna.

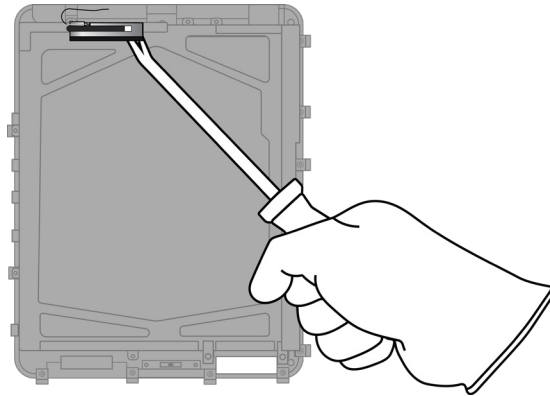

Tools Used

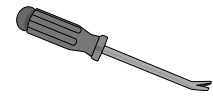

Fraction



Antenna



**6.** Remove the LCD cell.

» *Pry off the LCD cell bracket.*

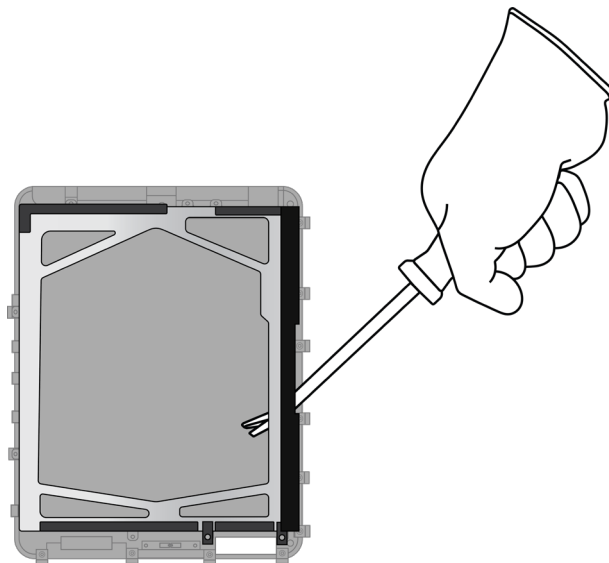

Tools Used

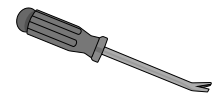

Fraction

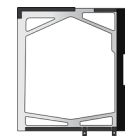

LCD cell bracket



» *Pry off the LCD cell.*

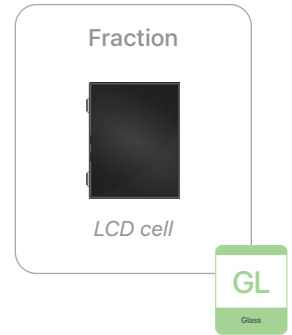

## 7. Remove the cover glass.

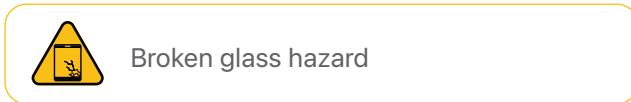

» *Pry off the cover glass bracket.*

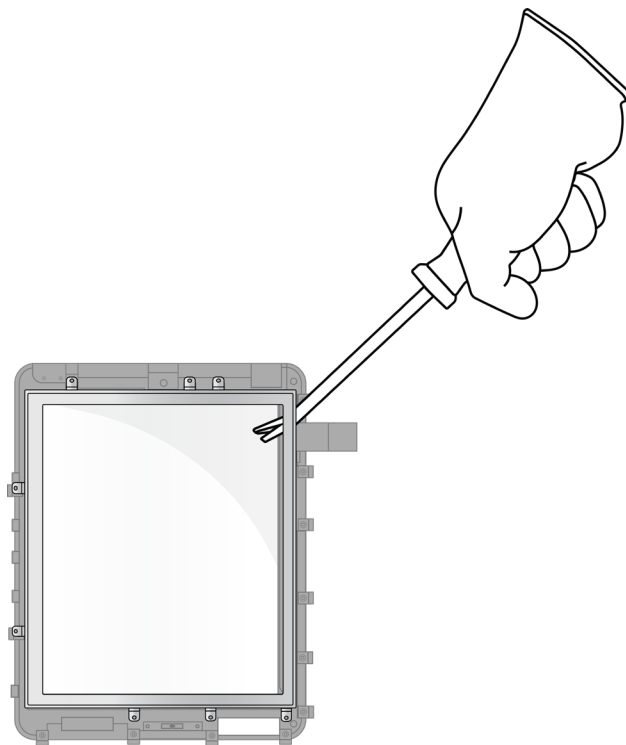
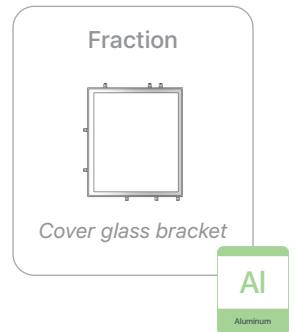
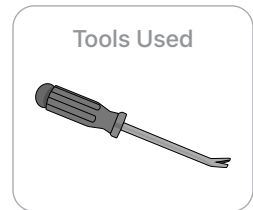

» Pull off the ribbon cable by hand.

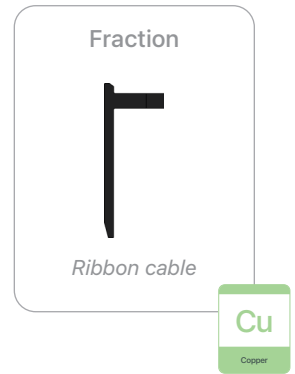
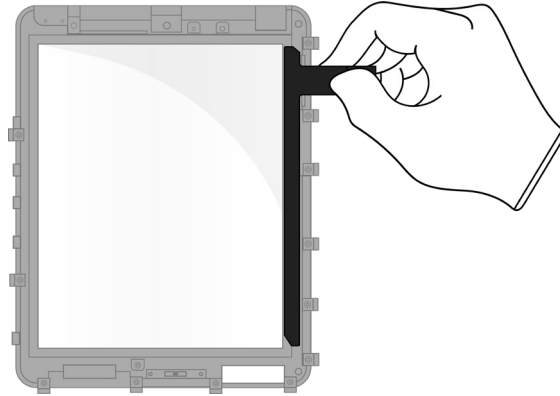

» Turn the display faceup. Pry off the cover glass.

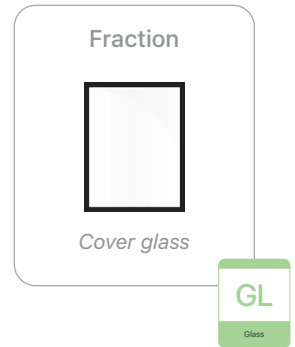
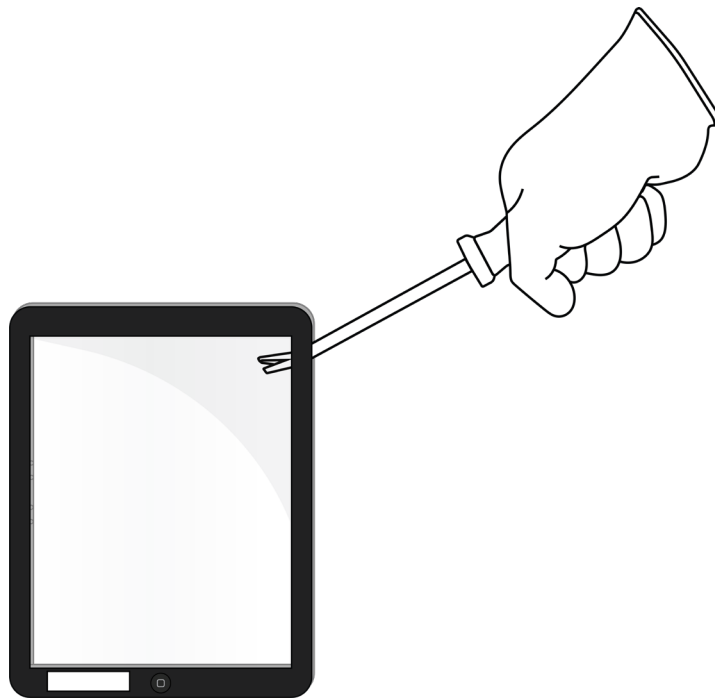

8. Pry off the antenna.

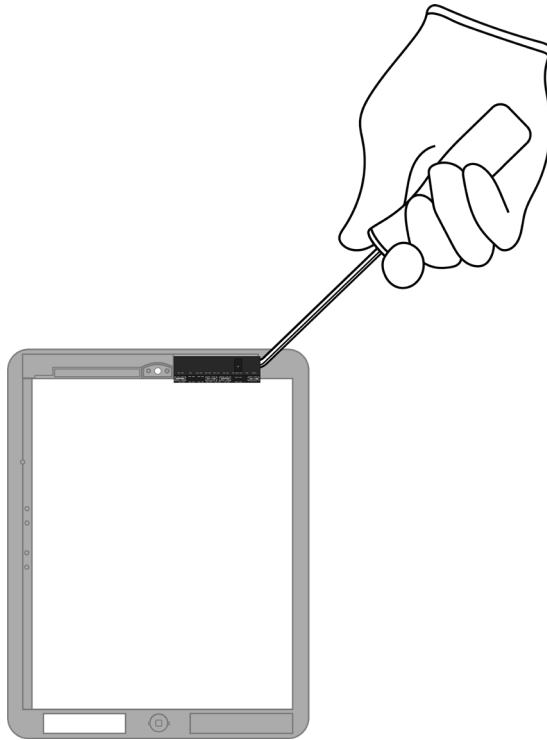

Tools Used



Fraction



Antenna

Cu

Copper

9. Pry off the Home button.

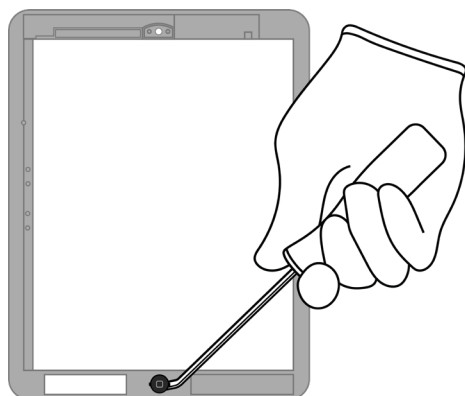

Tools Used



Fraction



Home button

Cu

Copper

Fraction



Display frame

PL

Plastics



**10.** From the enclosure, carefully remove both lithium-ion polymer batteries.

 Rechargeable battery hazard

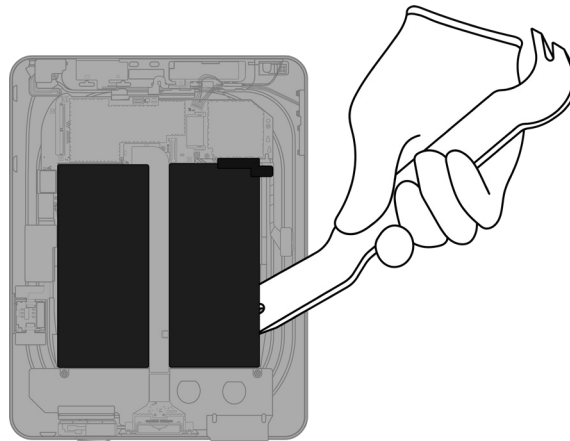

Tools Used



Fraction



Lithium-ion polymer batteries (x2)

**BT**  
Battery

**11.** Pry off the main logic board.

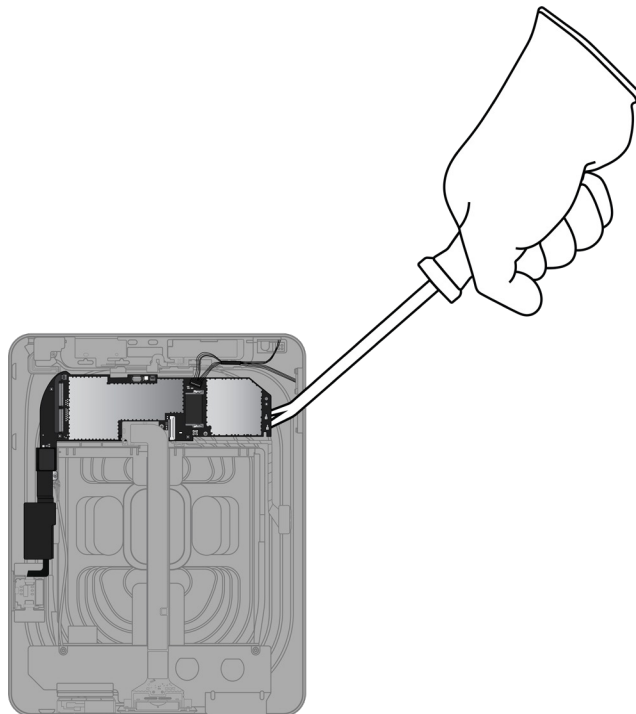

Tools Used

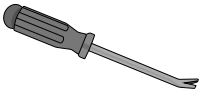

Fraction

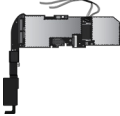

Main logic board

**PMs**  
Precious Metals

**12.** (Wi-Fi + Cellular model only) Pry off the GPS antenna.

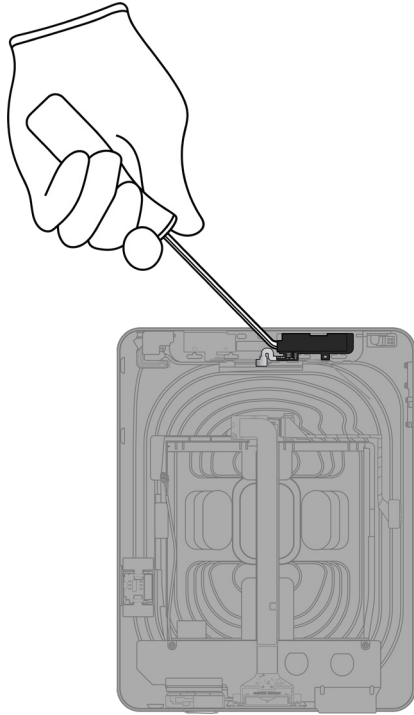

Tools Used



Fraction



GPS antenna

Cu

Copper

**13.** (Wi-Fi + Cellular model only) Pry off the cellular antenna.

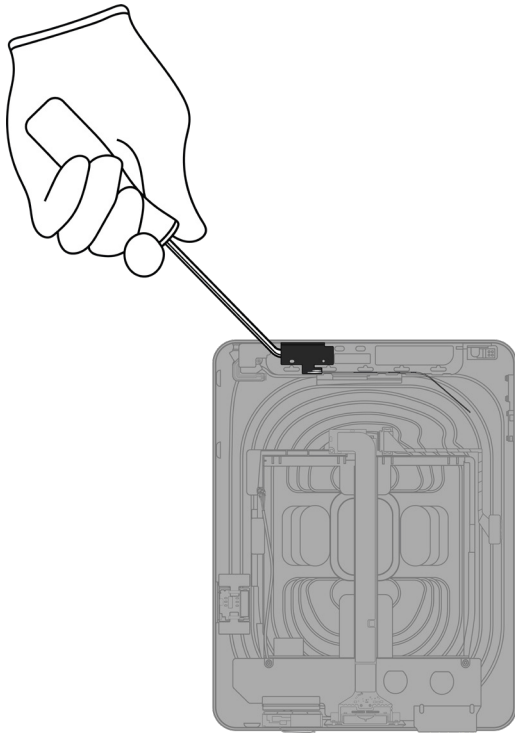

Tools Used



Fraction

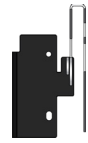

Cellular antenna

Cu

Copper

**14.** Pry off the headphone jack.

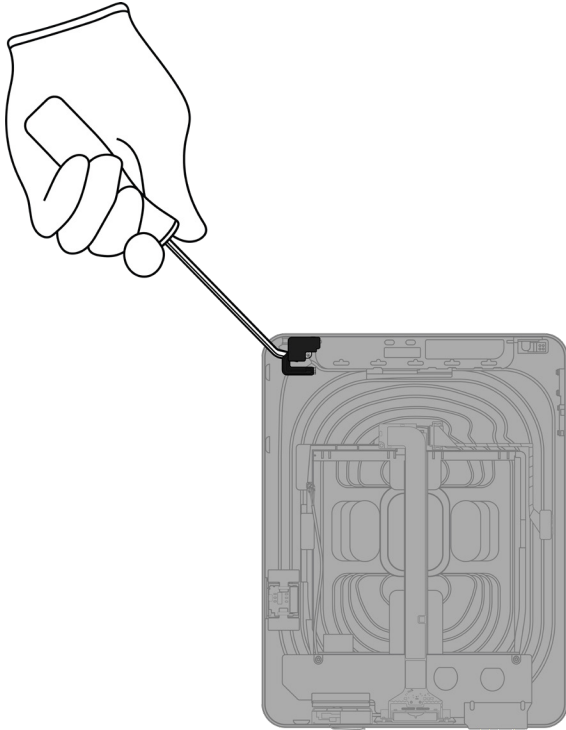

Tools Used



Fraction



Headphone jack

Cu  
Copper

# 15. (Wi-Fi + Cellular model only) Remove the SIM tray and SIM card.

» Remove the SIM tray.

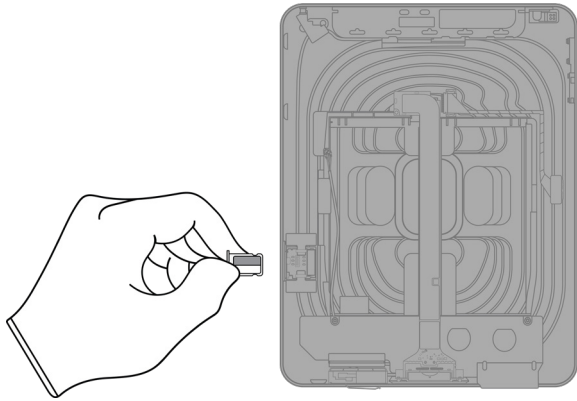

» Remove the SIM card from the SIM tray.

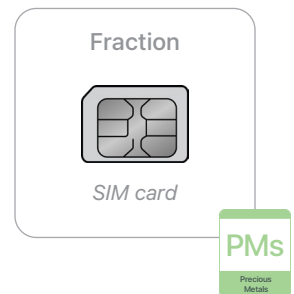
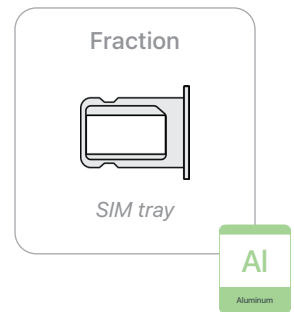
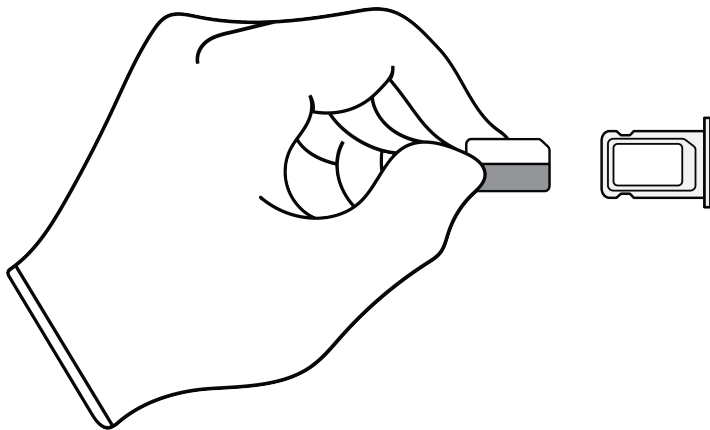

**16.** (Wi-Fi + Cellular model only) Pry off the SIM reader.

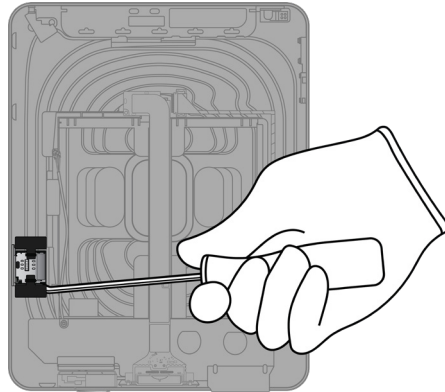

Tools Used



Fraction

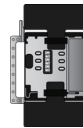

SIM reader

Cu

Copper

**17.** Pry off the charging port.

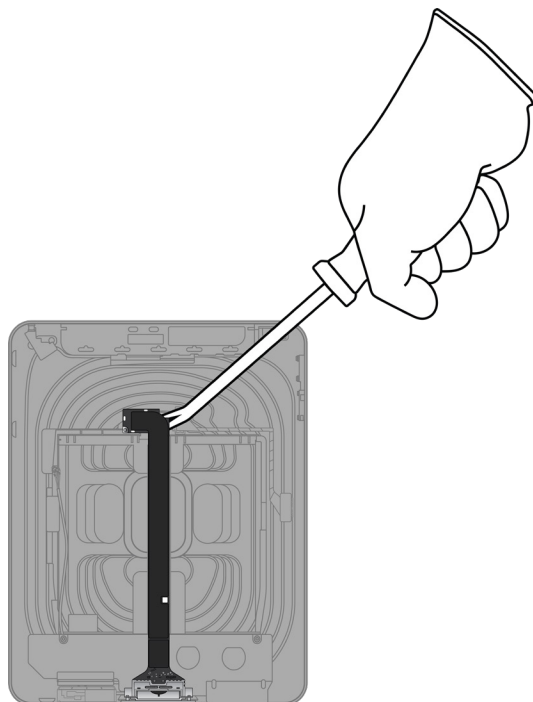

Tools Used

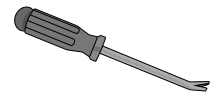

Fraction



Charging port

Cu

Copper

## 18. Pry off the speakers.

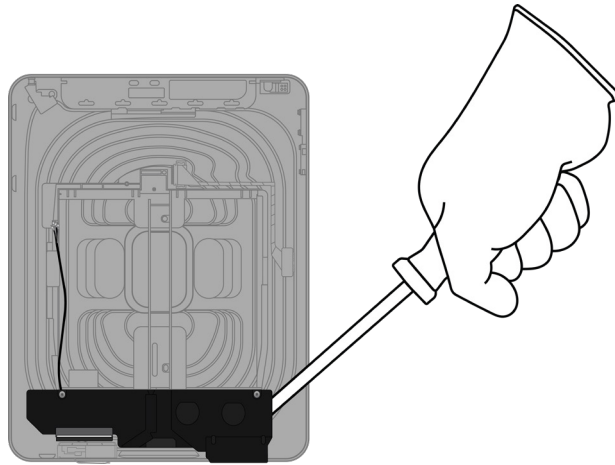

### Tools Used

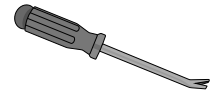

### Fraction



Speakers

REE  
Rare Earth  
Elements

## 19. Pry off the Wi-Fi antenna.

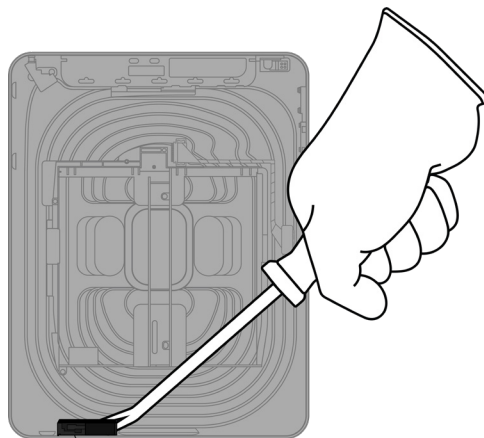

### Tools Used

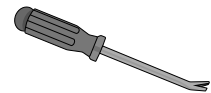

### Fraction



Wi-Fi antenna

Cu  
Copper

**20.** Pull off the ribbon cable.

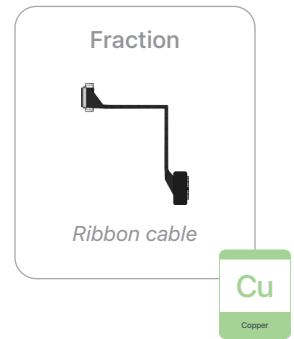
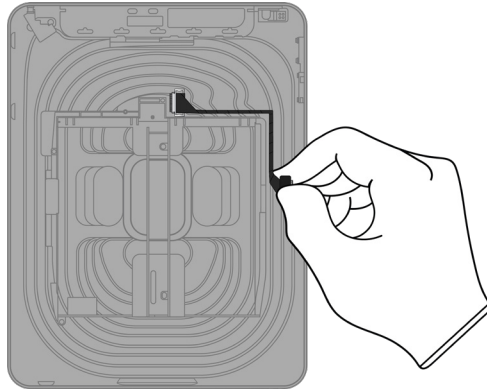



## 21. Pry off the battery bracket.

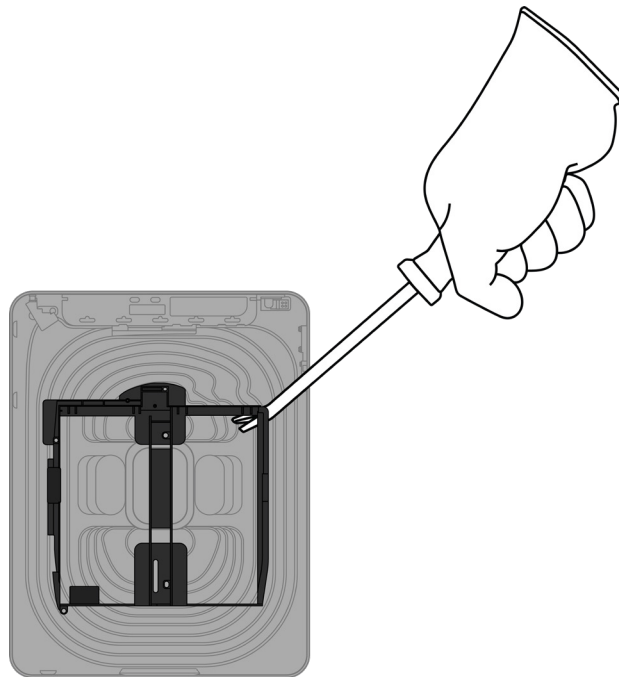

### Tools Used

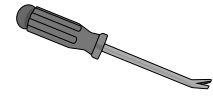

### Fraction



Battery bracket

PL

Plastics

### Fraction









Enclosure

Al

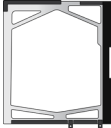
Aluminum

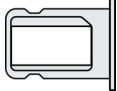
# Material Categorization of Output Fractions

All outputs from this process must be managed, handled, and disposed of in accordance with applicable waste laws and regulations, including but not limited to the Waste Framework Directive and its national enactments in Europe.

Fraction	Downstream Processing
<p><b>Aluminum</b></p>  <p><i>LCD cell bracket</i></p>  <p><i>Cover glass bracket</i></p>  <p><i>SIM tray</i></p>  <p><i>Enclosure</i></p>	<p><b>Primary Target Material</b></p>  <p><b>Potential Additional Materials</b></p> 

**Fraction**

**Downstream Processing**

**Batteries**



*Lithium-ion polymer batteries (x2)*

**Primary Target Material**



**Glass**



*LCD cell*



*Cover glass*

**Primary Target Material**



**Potential Additional Materials**



**Fraction**

**Downstream Processing**

**Logic Boards**



*Display logic board*



*Main logic board*



*SIM card*

**Primary Target Material**



**Potential Additional Materials**



**Fraction**

**Downstream Processing**

**Mixed Electronics**

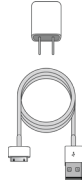

*Charge cable and adapter*



*Light sensor*



*Antennas*



*Home button*



*GPS antenna*

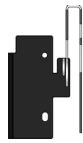

*Cellular antenna*

**Primary Target Material**



**Potential Additional Materials**



Mixed Electronics (cont.)



Headphone jack

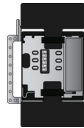

SIM reader



Charging port



Wi-Fi antenna

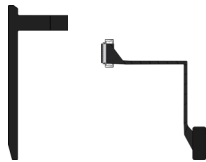

Ribbon cables

**Fraction**

**Downstream Processing**

**Mixed Plastics**

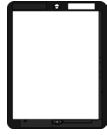

*Display frame*



*Battery bracket*

**Primary Target Material**



**Potential Additional Materials**



**Rare Earth Magnets**



*Speakers*

**Primary Target Material**



**Potential Additional Materials**

